



User`s manual



# Simulation of Monorail Train Dynamics

## Contents

<b>26. UM MODULE FOR SIMULATION OF MONORAIL TRAINS.....</b>	<b>1-3</b>
<b>26.1. GENERAL INFORMATION.....</b>	<b>1-3</b>
<b>26.2. BASE SYSTEM OF COORDINATES .....</b>	<b>1-4</b>
<b>26.3. DEVELOPMENT OF VEHICLE MODEL.....</b>	<b>1-5</b>
26.3.1. Monorail identification .....	1-5
26.3.2. Modeling wheels .....	1-6
26.3.3. Suspension springs and shock absorbers.....	1-8
26.3.4. Air springs.....	1-8
26.3.5. Bushings.....	1-9
26.3.6. Longitudinal velocity control.....	1-10
<b>26.4. TRACK MACRO PROFILE AND ROUGHNESS .....</b>	<b>1-11</b>
26.4.1. Track macro profile.....	1-11
26.4.2. Track macrogeometry in horizontal plane .....	1-12
26.4.2.1. Tangent section .....	1-12
26.4.2.2. Curve section .....	1-13
26.4.2.2.1. Point curve.....	1-13
26.4.3. Track macrogeometry in vertical plane.....	1-15
26.4.3.1. Constant slope section .....	1-16
26.4.3.2. Point section.....	1-16
26.4.4. Track roughness (irregularities) .....	1-18
26.4.4.1. Assigning irregularities.....	1-20
26.4.5. Special track deviations .....	1-21
<b>26.5. TIRE MODELS.....</b>	<b>1-24</b>
<b>26.6. TRACK MODELS .....</b>	<b>1-25</b>
26.6.1. Flexible track parameters .....	1-25
<b>26.7. SIMULATION OF MONORAIL DYNAMICS.....</b>	<b>1-27</b>
26.7.1. Preparing for simulation.....	1-27
26.7.1.1. Identification of longitudinal velocity control .....	1-29
26.7.1.2. Creating longitudinal velocity functions.....	1-30
26.7.1.3. Creating beam section profile .....	1-31
26.7.2. Modes of longitudinal motion of monorail .....	1-33
26.7.2.1. Neutral .....	1-33
26.7.2.2. $v=\text{const.}$ .....	1-33
26.7.2.3. Profile .....	1-34
26.7.2.4. $v=0$ .....	1-34
26.7.3. Monorail train specific variables.....	1-36
26.7.3.1. Tire/road contact variables.....	1-36
26.7.3.2. Kinematic characteristics relative to track system of coordinates .....	1-37
<b>26.8. SIMULATION OF TRACK AS FEM SUBSYSTEM .....</b>	<b>1-38</b>
26.8.1. Development of FEM subsystem .....	1-38
26.8.2. Simulation of vehicle-track interaction .....	1-44
26.8.3. Examples.....	1-48

# 1. UM Module for simulation of monorail trains

## 1.1. General information

Program package Universal Mechanism includes a specialized module **UM Monorail Train** for analysis of 3D dynamics of both single vehicle and trains. The module includes additional tools integrated into the program kernel.

The module is available in the UM configuration if the sign + is set in the corresponding line of the **About** window, the **Help | About...** menu command, Figure 1.1.



Figure 1.1. UM Monorail Train module is available

**UM Monorail Train** contains the following main components:

- tools for generation and visualization of guideway structure (bridge) geometry;
- tools for generation and visualization of guideway roughness (irregularities);
- mathematical models of tire forces (tire/road contact forces);
- set of typical dynamic experiments.

**UM Monorail Train** allows the user to solve the following problems:

- estimation of vehicle vibrations due to irregularities;
- estimation of vehicle dynamic performances on curving;
- parametric optimization of vehicle elements according to various criteria;
- longitudinal forces and vibrations for trains.

## 1.2. Base system of coordinates

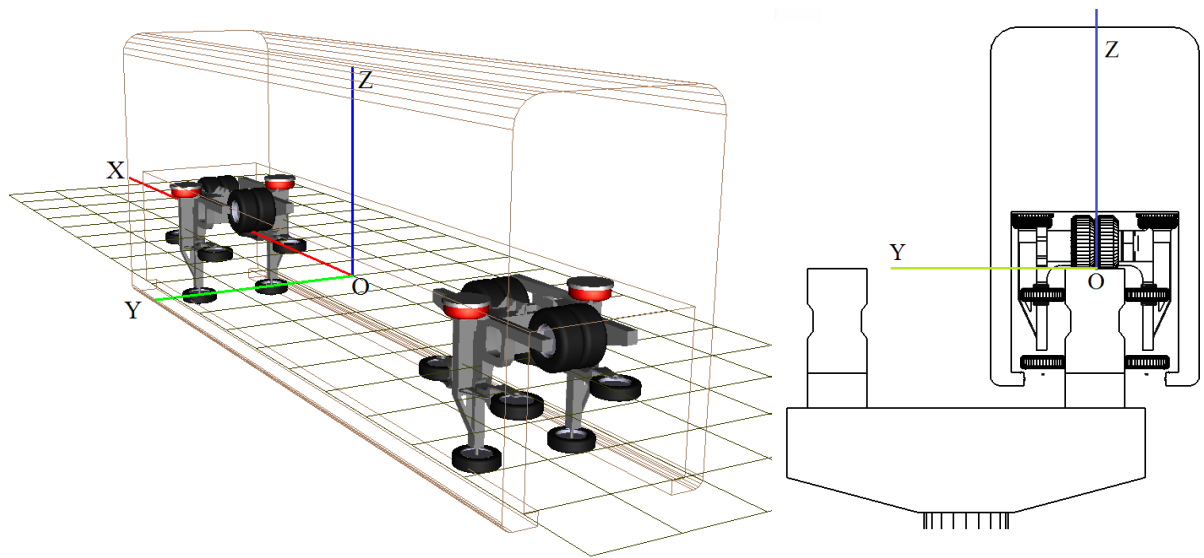

Figure 1.2. Base system of coordinates (SC0)

Inertial system of coordinates (SC0) in UM Monorail Train meets the following requirements (Figure 1.2).

- Axis Z is vertical, axis X coincides with the vehicle longitudinal axis at its ideal position at the moment of motion start; direction of X axis corresponds to the motion direction of the vehicle.
- Origin of SC0 lies at the centerline of the ideal upper surface of track beam, i.e. the surface for driving wheels.

## 1.3. Development of vehicle model

The user develops the vehicle model in UM Input.exe program. The model consists of bodies, joints and force element. We recommend to start the model development with studying the model delivered with UM [{UM Data}\Samples\Monorail vehicle](#).

### 1.3.1. Monorail identification

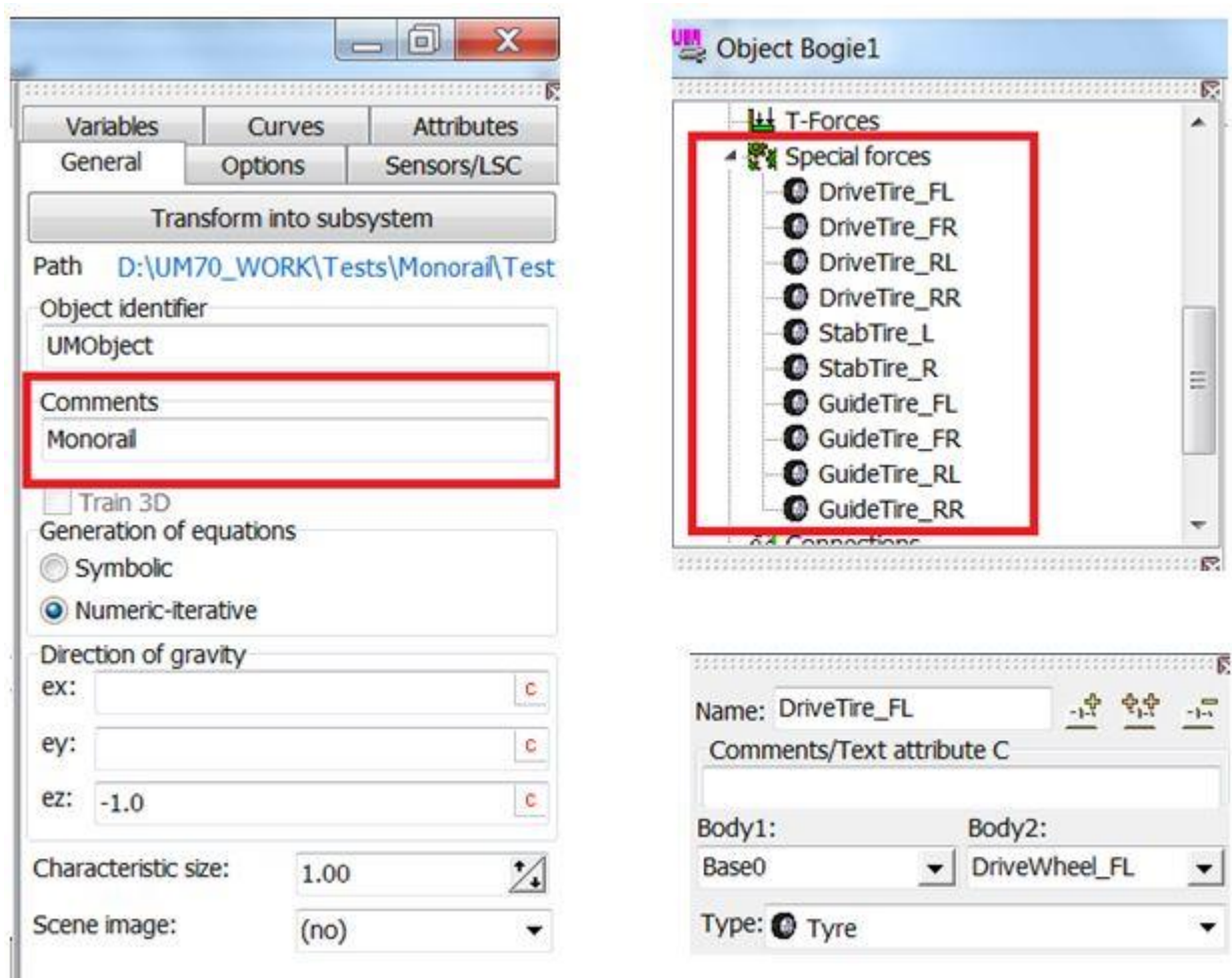

Figure 1.3. Text attribute 'Monorail'. Special forces 'Tires'

UM identifies the model as a monorail vehicle or a monorail train if the following two requirements are met in the model description:

- The standard text comment 'Monorail' must be set in the **Comments** box on the **General** tab of the data inspector, Figure 1.3, left;
- Special forces of the **Tire** type are assigned to the wheels, Figure 1.3, right.

### 1.3.2. Modeling wheels

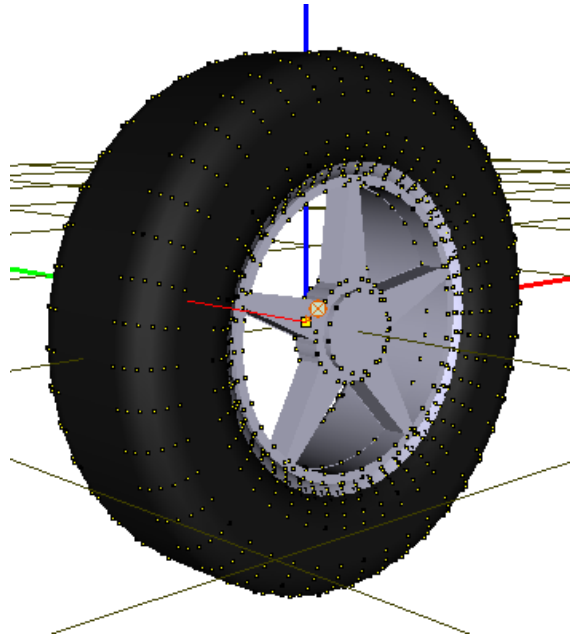

Figure 1.4. Model of a wheel as a body

A wheel in the UM model of a vehicle is a usual rigid body with assigned image and inertia parameters, Figure 1.4. The following special features distinguish the wheel from other bodies in the model.

- Center of mass is located at the origin of the wheel-fixed system of coordinates (SC).
- Wheel rotation axis coincides with the Y-axis of the wheel-fixed SC.
- A special force element of **Tire** type should be created for each of the wheel, Figure 1.3, right.
- The wheel should be connected to the vehicle by a rotational joint; **increment of joint coordinates must correspond to the motion of the vehicle ahead.**

In case of guiding and stabilizing wheels, the last requirements can be met if one of the joint vectors has opposite directions for the left and right wheels because the wheels rotate in different directions. Examples of rotational joints for the left and right guiding wheels are shown in Figure 1.5, Figure 1.6. Bogie-fixed joint vector for the left wheel is directed downwards whereas for the right wheel it is directed upwards.

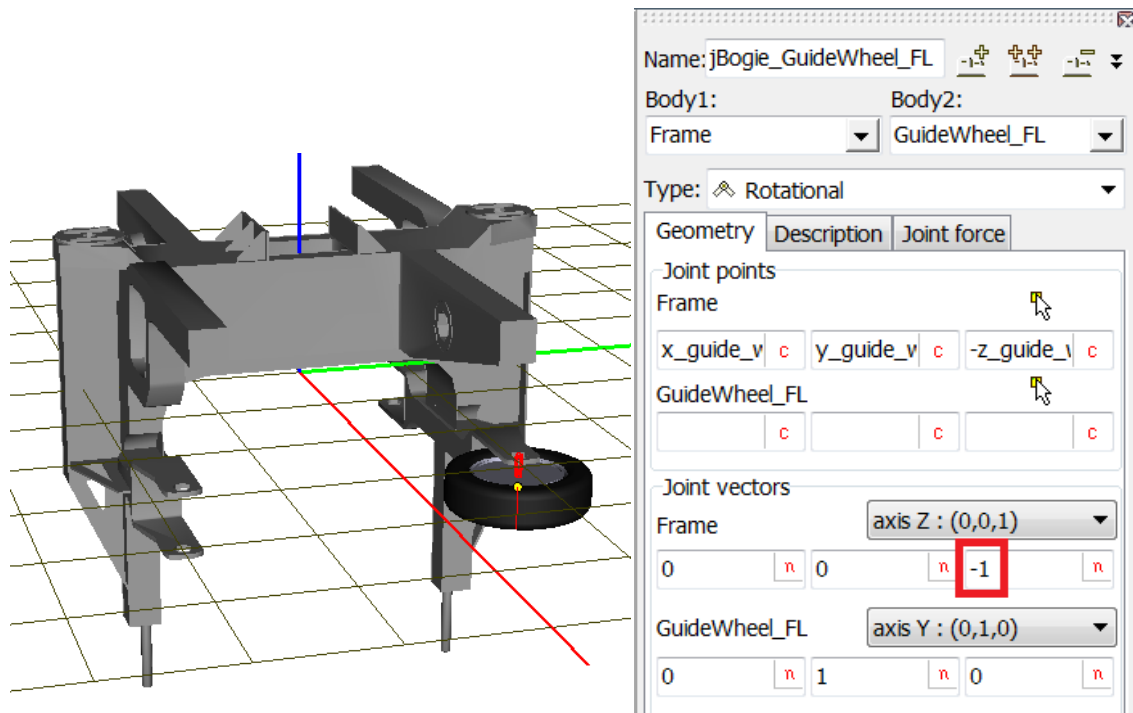

Figure 1.5. Joint for the left guiding wheel

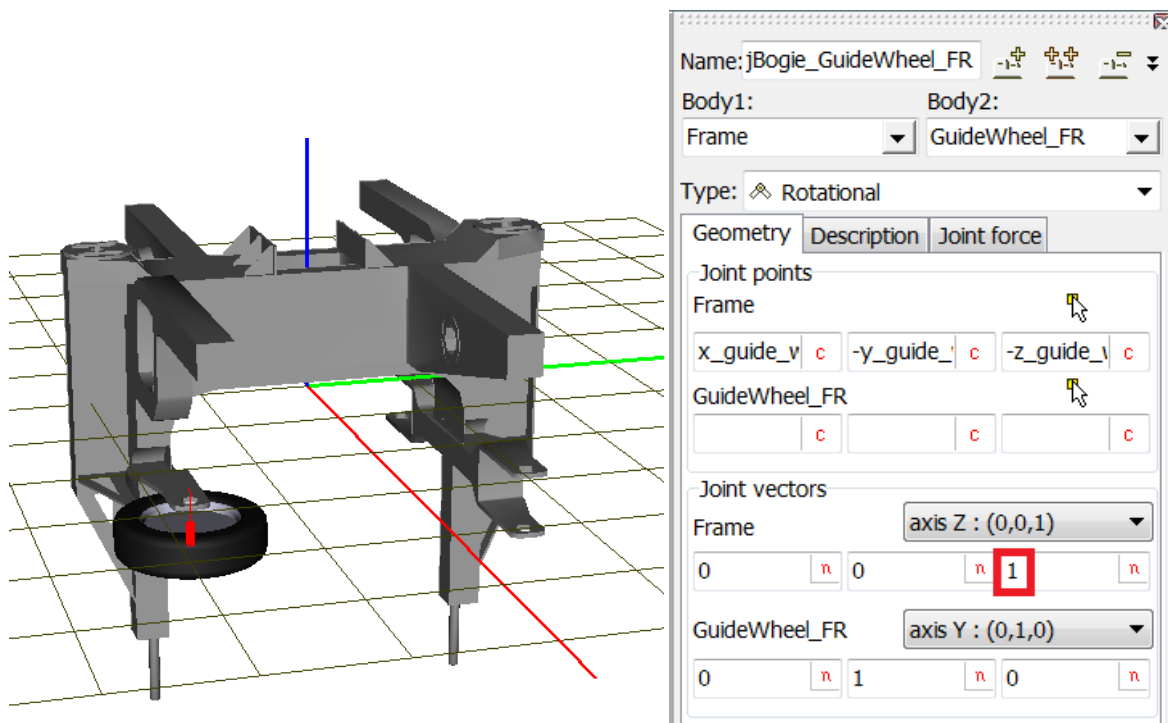



Figure 1.6. Joint for the right guiding wheel

We could recommend the following method for verification the correctness of joint description, Figure 1.7.

- Set the contour type of graphics in the animation window by the  button in the top of the window.
- Open the **Description** tab in the data inspector. Change the value of the coordinates 1,2,3... degrees and watch the direction of the wheel rotation.

- If the direction is false, change the direction of the bogie-fixed joint vector on the **Geometry** tab.

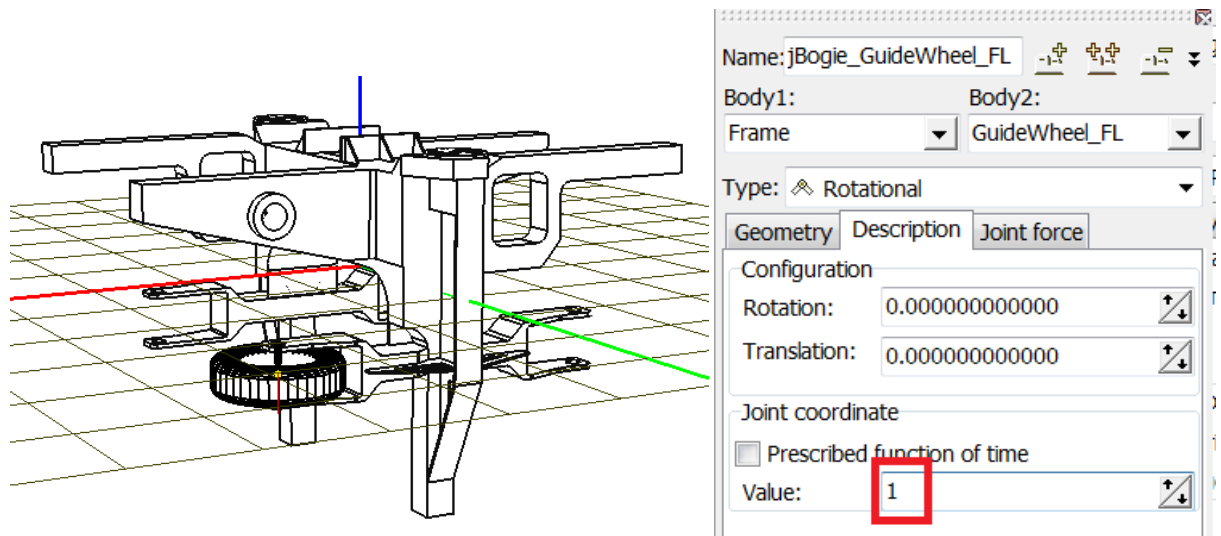

Figure 1.7. Increase of the joint coordinate

### 1.3.3. Suspension springs and shock absorbers

Linear suspension springs can be modeled by the *generalized linear force elements* ([Chapter 2](#)) if a stiffness matrix describes their stiffness properties.

Both linear and nonlinear bipolar springs and shock absorbers can be modeled by *bipolar force elements* ([Chapter 2](#)).

### 1.3.4. Air springs

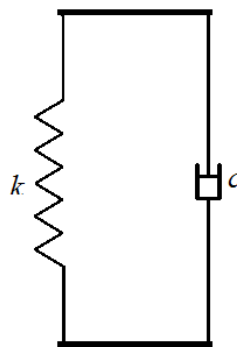

Figure 1.8. Simplest model of air spring

The simplest model of an air spring is shown in Figure 1.8. A bipolar force element of the *Expression* type describes this model, the expression is

$$-k * (x - x_0) - c * v$$

where  $C, D$  are the stiffness and damping constants,  $x_0$  is the undeformed length of the element.

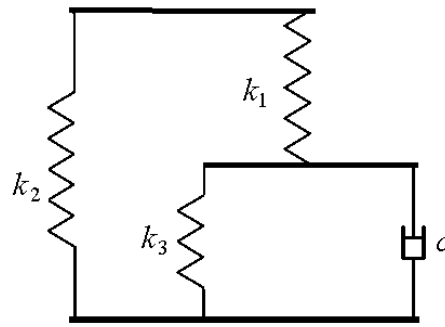

Figure 1.9. Nishimura model of air spring

The known Nishimura model of an air spring (Figure 1.9) is created as a bipolar force element ‘List of forces’ with two subelements: linear elastic and viscous-elastic ([Chapter 2](#)).

The stiffness and damping constants for the model are calculated according to the following formulas:

$$k_1 = nA_e^2 \frac{p_0}{V_r}, k_3 = nA_e^2 \frac{p_0}{V_b}, k_2 = (p_0 - p_a) \frac{dA_e}{dx},$$

$$c = R_f A_e^2 \rho_0 g.$$

Here  $A_e$  is the effective area of the spring,  $p_0, p_a$  are the initial absolute pressure and the atmospheric one,  $V_r, V_a$  are the reservoir and the air bug volumes,  $x$  is the coordinate,  $g$  is the gravity acceleration,  $R_f = 0.126/d_s^3$  is the flow resistance coefficient,  $d_s$  is the diameter of the surge pipe. The number  $n$  is frequency dependent,  $n = 1$  for low frequencies ( $<0.1\text{Hz}$ ) and  $n = 1.4$  for higher frequencies ( $>3\text{Hz}$ ).

### 1.3.5. Bushings

UM supports both linear and nonlinear bushings. The mathematical model of bushings is described in [Chapter 2](#), Sect. *Special forces/Bushings*. Input of the element parameters see in [Chapter 3](#), Sect. *Data Input / Input of force elements / Special forces / Bushings*.

### 1.3.6. Longitudinal velocity control

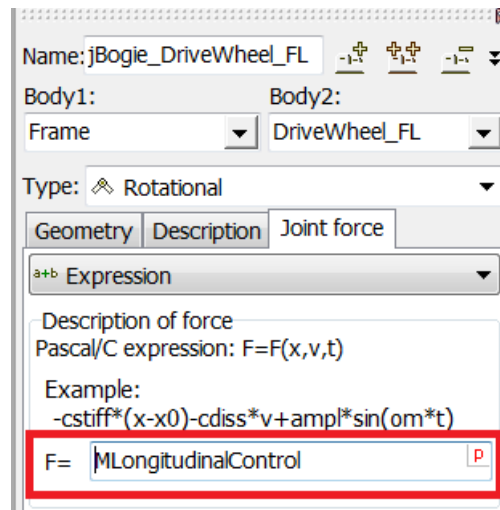

Figure 1.10. Joint torque for longitudinal velocity control

To make possible a control of the vehicle longitudinal velocity, the model of a vehicle needs a special traction joint torque. In the simplest case the torque is introduced in the driving wheel joint, which is a rotational joint connecting the driving wheel, Figure 1.10. The model of the control torque is described as a joint torque of the *Expression* type by one and the same identifier for all of the driving wheels. The default identifier is (recommended)

*MLongitudinalControl*

The user may introduce another name of identifier.

## 1.4. Track macro profile and roughness

Guideway geometry is composed of two components: macro profile, and roughness.

### 1.4.1. Track macro profile

Track macro profile contains 3D information about the geometry of the centerline on the top of guiding beam. The centerline is composed of the horizontal (X-Y) and vertical profiles, which assumed to be independent. Both horizontal and vertical profiles are stored in \*.mcg text files located by default in the {UM Data}\Monorail\Macroeometry directory.

The **horizontal profile** includes any number of tangent sections, standard curves and plane curves specified by a set of points with optional smoothing by splines. The **standard curve** consists of two **transient sections** and a **steady section** with constant radius. The transient sections are the Euler's (Cornu's) spiral (clothoid), i.e. a plane curve whose curvature changes linearly with the curve length. Thus, the curvature increases from zero to the given value at the start transient section, is constant within the steady section, and finally decreases to zero at the end transient section.

The **horizontal profile** consists of any number of sections with constant slope and sections specified by a set of points with optional smoothing by splines. Coupling of sections with constant slopes is smoothed by circles with the given radii.

To generate a macro geometry file use the **Tools | Create macrogeometry...** menu command in **UM Simulation** program. The wizard of macro geometry appears (Figure 1.11).

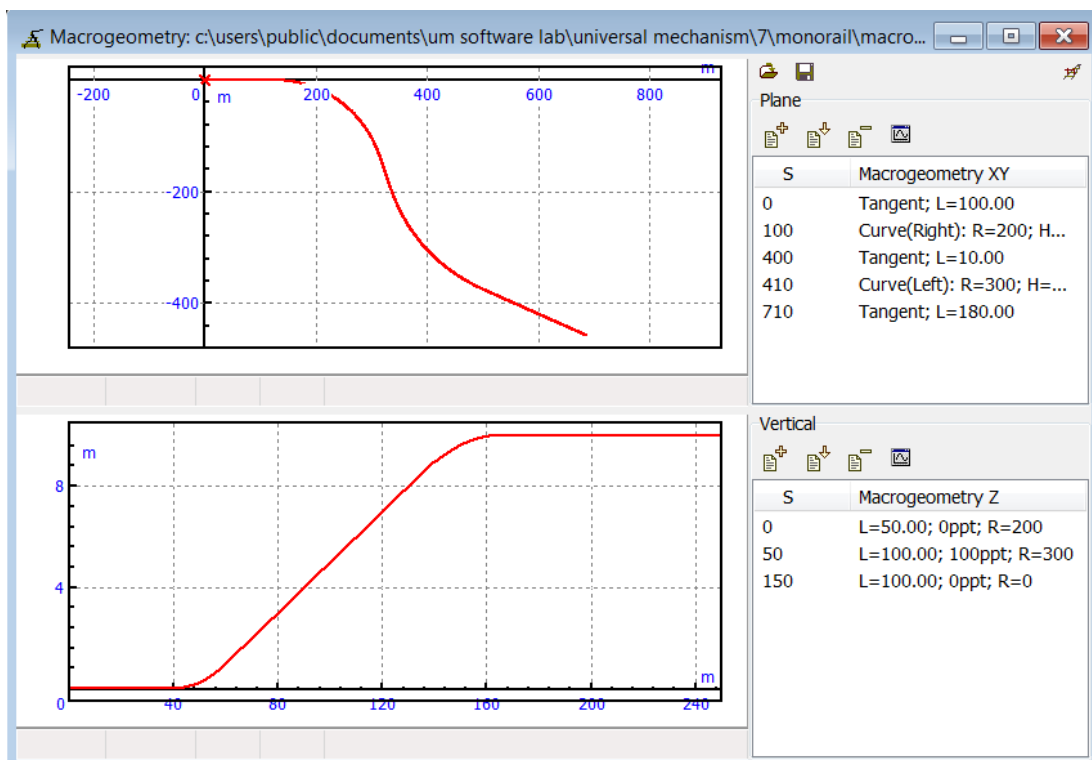

Figure 1.11. Wizard of macro geometry. Horizontal (upper plot) and vertical (lower plot) profiles

### 1.4.2. Track macrogeometry in horizontal plane

The upper part of the window in Figure 1.11 is used for description of the track geometry in the horizontal plane.

- To *add* a section, click on the  button and select the section type in the menu.

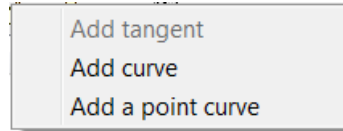



Figure 1.12. Section menu

- To *edit* the section parameters double click on the corresponding line of the section list or select the line and press Enter.
- To *insert* a section before the selected one, click on the  button.
- The button  *removes* the selected section from the list.

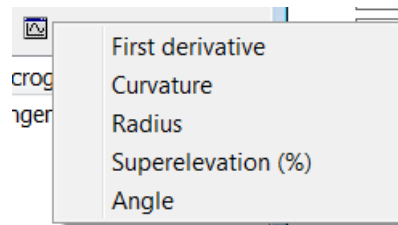



Figure 1.13. Additional plot information about profile

- The  button allows the user to get some useful information about the horizontal profile like curvature and superelevation.

#### 1.4.2.1. Tangent section

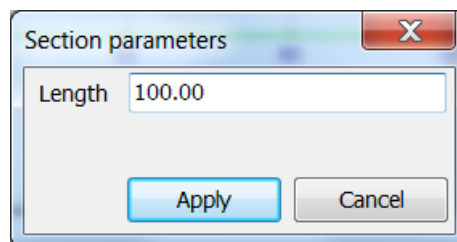

Figure 1.14. Parameters of a tangent section

Tangent section window contains the values of section length.

### 1.4.2.2. Curve section

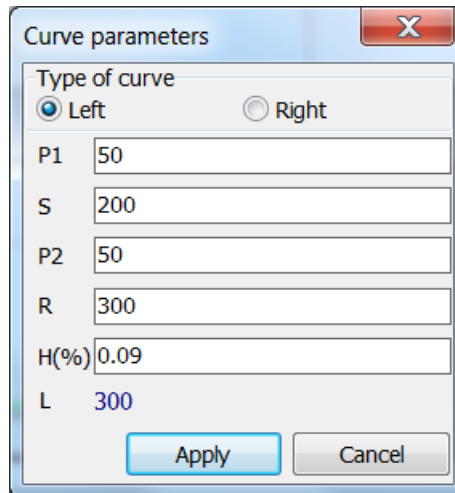

Figure 1.15. Window with curve parameters

Curve parameter window includes

- type of curve (left or right);
- geometric parameters of the curve: lengths of transient sections (P1, P2), length of steady curve section (S), radius (R), superelevation (H).

#### 1.4.2.2.1. Point curve

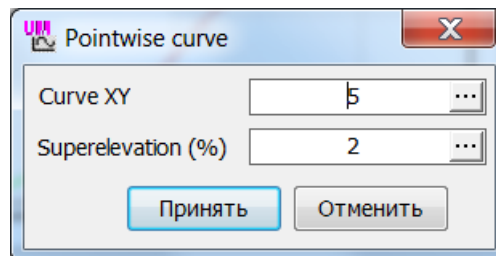



Figure 1.16. Point curve parameter window

Point curve can be used for the pointwise description of guideway horizontal geometry. Press  button for editing of the curve parameter in the curve editor.

- **Curve XY**

Curve editor is used for setting the guide beam centerline projection in XY plane. The section length is evaluated automatically as a length of XY curve.

**The first point must have zero coordinates. The tangent to the curve at the first point must be equal to the positive direction of X axis.**

Number of points and curve length are not limited. For example, it can be measured field data or analytically computed coordinates of nonstandard transient curve section.

The point list can be as follows:

X	Y	X	Y
0	0	26	0.4394
2	0.0002	28	0.5488
4	0.0016	30	0.675
6	0.0054	32	0.8192
8	0.0128	34	0.9826
10	0.025	36	1.1664
12	0.0432	38	1.3718
14	0.0686	40	1.6
16	0.1024	42	1.8522
18	0.1458	44	2.1296
20	0.2	46	2.4334
22	0.2662	48	2.7648
24	0.3456	50	3.125
26	0.4394		

The list is recommended to be prepared in MS Excel as a two-column table. Then it is copied to clipboard and pasted to the curve editor (all other points must be preliminary deleted from the curve editor list!). The curve is shown in Figure 1.17. B-Spline smoothing is recommended for the curve approximation. Automatically evaluated curve length is shown in Figure 1.18.

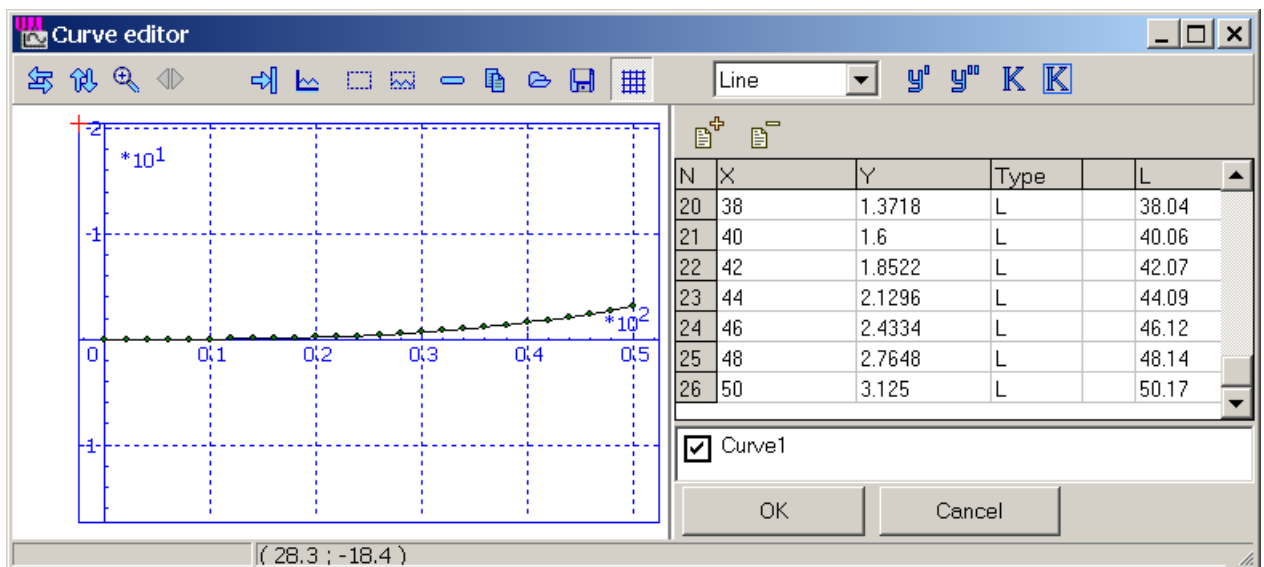

Figure 1.17. XY curve editor

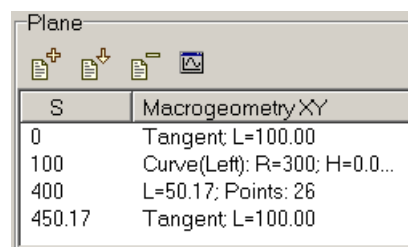

Figure 1.18. Point curve length

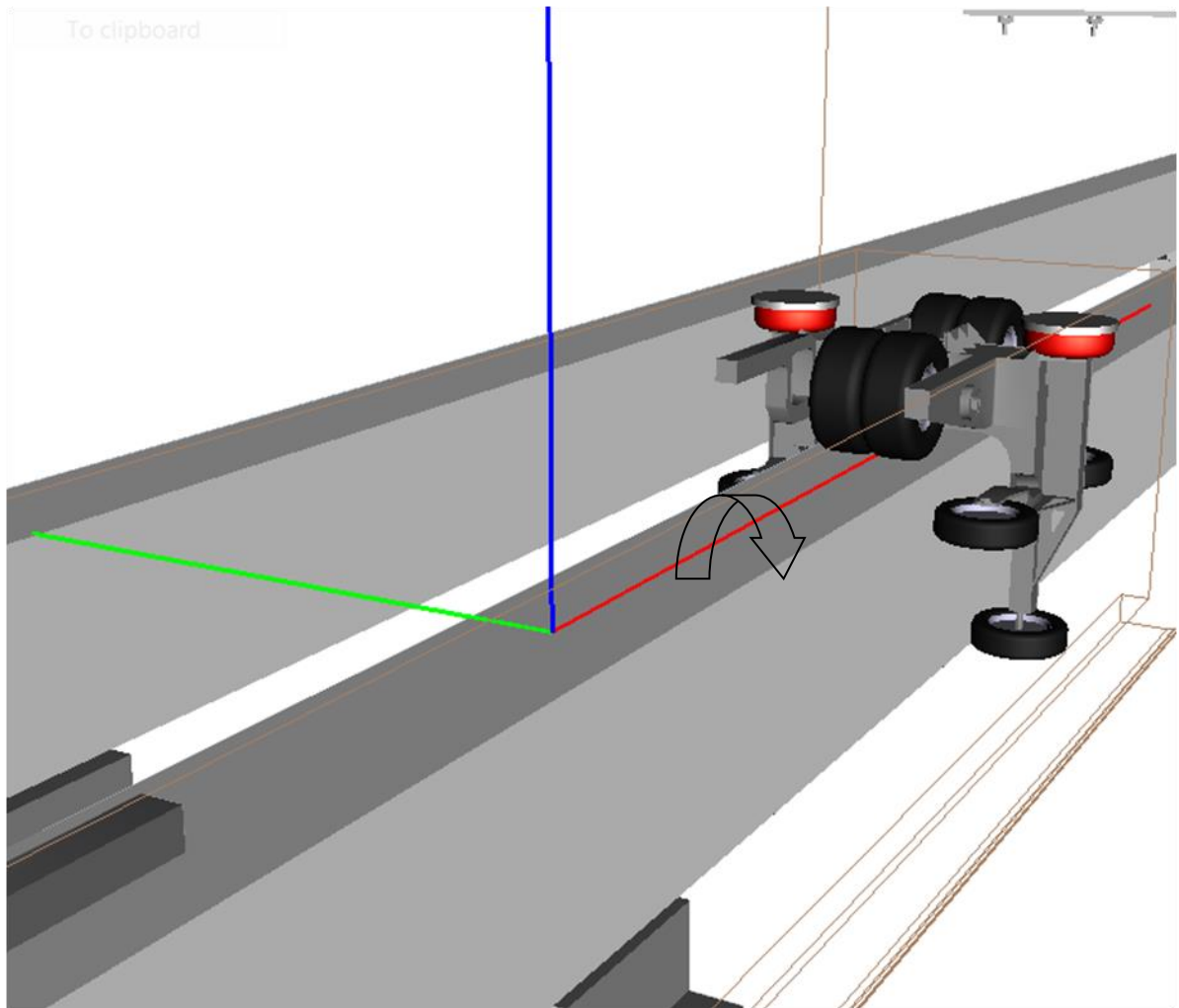

Figure 1.19. Direction of positive superelevation

- **Superelevation**

Superelevation is a function of the XY curve length. The user may use the length data evaluated in the last column in point table, Figure 1.17.

The positive direction of superelevation is show in Figure 1.19.

**Remark.** The user should take care of the continuity of superelevation function.

### 1.4.3. Track macrogeometry in vertical plane

The lower part of the window in Figure 1.20 is used for description of the track geometry in the vertical plane.

- To *add* a section, click on the  button and select the section type in the menu.

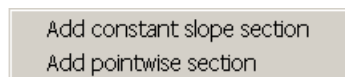

Figure 1.20. Section menu

- To *edit* the section parameters double click on the corresponding line of the section list or select the line and press Enter.

### 1.4.3.1. Constant slope section

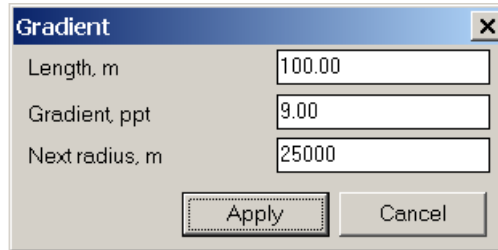

Figure 1.21. Constant slope section parameters

The following parameters can be set in Gradient window (Figure 1.21):

- length of section (m);
- gradient in ppt (parts per thousand or meters per kilometer);
- radius of circle on smoothing the gradient change.

### 1.4.3.2. Point section

Point curve can be used for the description of vertical guide beam centerline coordinate as a function of the XY curve length. Curve editor is used for description of functions, see Figure 1.22. Curve editor opens when section editing starts.

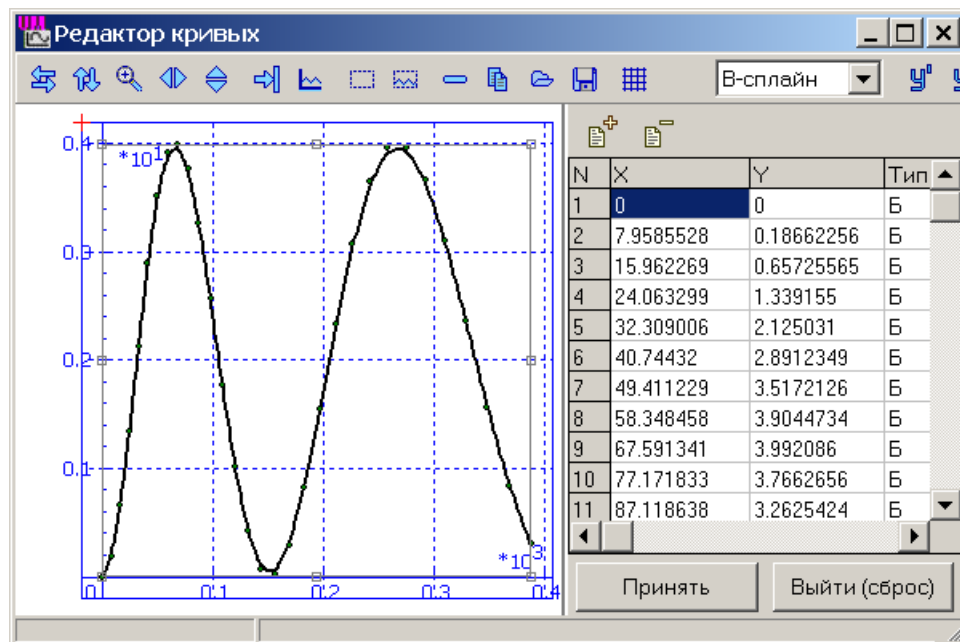

Figure 1.22. Parameters of point section

X parameter corresponds to curve length value; Y parameter – to Z coordinate of track axis. B-Splines are recommended for approximation.

**Remarks.** Use zero smoothing radius value for constant slope section if point section is next to it, otherwise the vertical profile will have a break of tangent.

### 1.4.4. Track roughness (irregularities)

Development of track roughness (irregularities) files \*.irr is considered in details in [Chapter 12](#) file, Sect. *Micro profile (irregularities)*.

Here we consider some features related to monorail trains.

- **Driving wheels**

Unlike the road vehicles, equal irregularities are assumed to the left and right driving wheel, i.e. only one \*.irr file is required for the vertical track roughness description.

- **Guiding and stabilizing wheels**

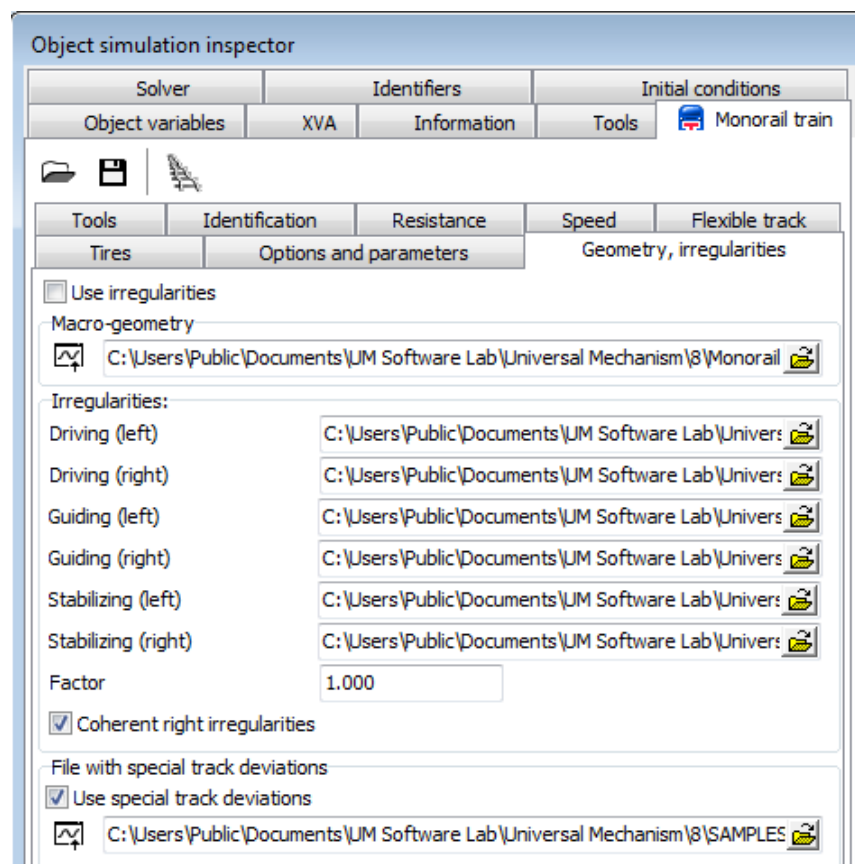

Figure 1.23. Parameter “Coherent right irregularities”

Description of irregularities for the left and right wheels depends on the key **Coherent right irregularities**, Figure 1.25. This key affects the sign of the irregularity height for the right wheels only. If the key is checked, positive directions for the left and right irregularities are the same. If not, the direction for the right irregularities changes to opposite one, Figure 1.24.

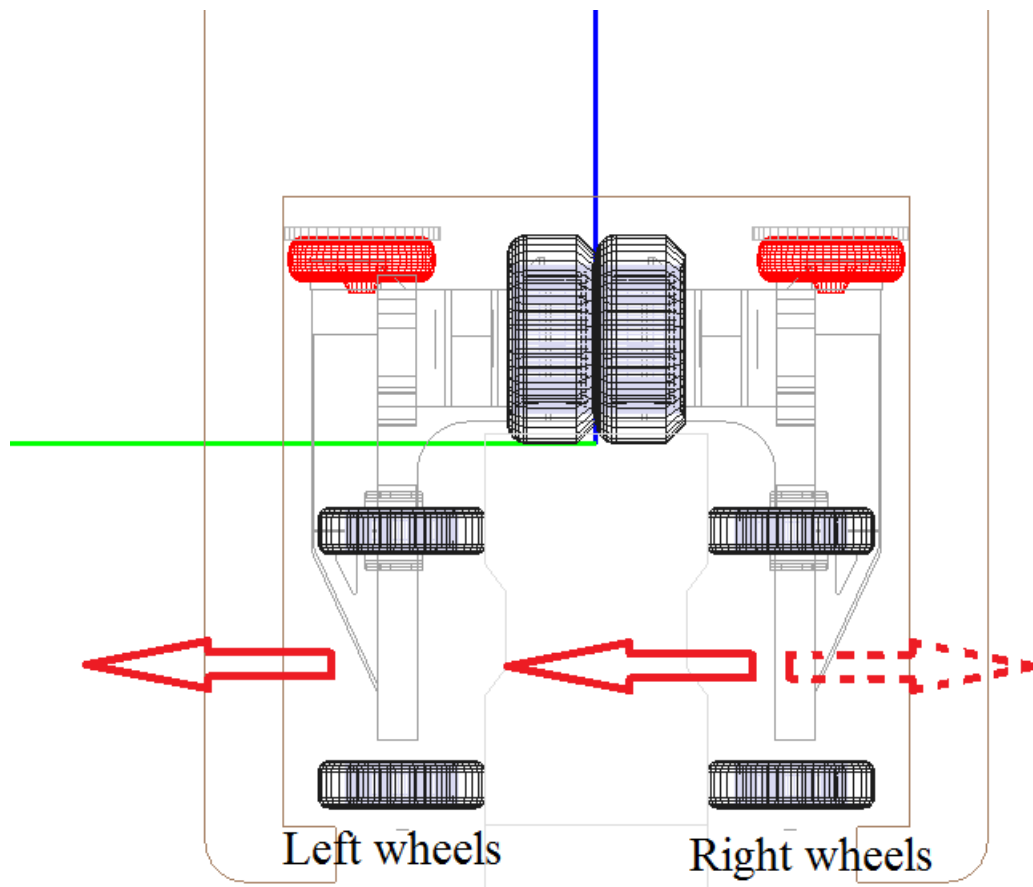

Figure 1.24. Positive direction of left and right irregularities for different values of the key “Coherent right irregularities”

One of the possible ways to define the horizontal beam irregularities is to consider them as a sum of two functions: horizontal irregularities of the beam centerline  $y_c(s)$  and deviation in the beam width from the constant value  $y_w(s)$ . In this case the irregularities for the left and right wheels are

$$y_l(s) = y_c(s) + y_w(s) / 2$$

$$y_r(s) = y_c(s) - y_w(s) / 2$$

if the key **Coherent right irregularities** is checked and

$$y_l(s) = y_c(s) + y_w(s) / 2$$

$$y_r(s) = -y_c(s) + y_w(s) / 2$$

otherwise.

If the irregularities for the left and right wheels are independent stochastic functions, the key value can be ignored.

### 1.4.4.1. Assigning irregularities

Use the **Monorail train | Options and Parameter** tab of the **Object simulation inspector** to select the irregularity files for the wheels by clicking the  buttons (Figure 1.23). Paths to selected files are stored in the configuration file \*.mrt.

Current irregularities are visualized by clicking the  button.

Irregularity profiles are corrected at the first two-meter distance to provide a smooth run of a vehicle on the irregularities, Figure 1.25. Thus, the vehicle at start is always on an absolutely even horizontal plane.

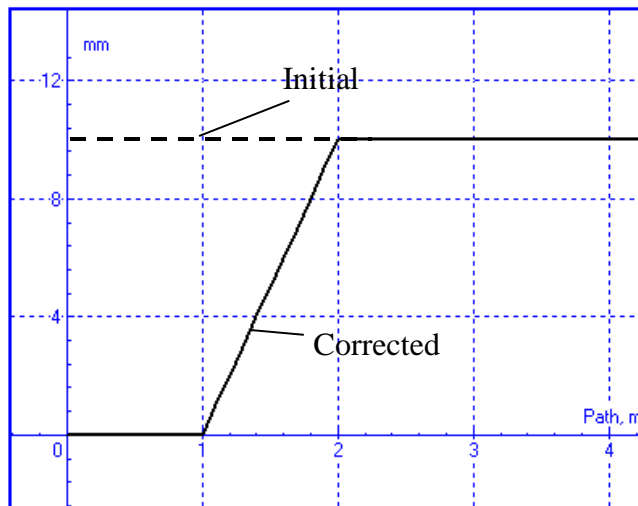

Figure 1.25. Correction of irregularities

### 1.4.5. Special track deviations

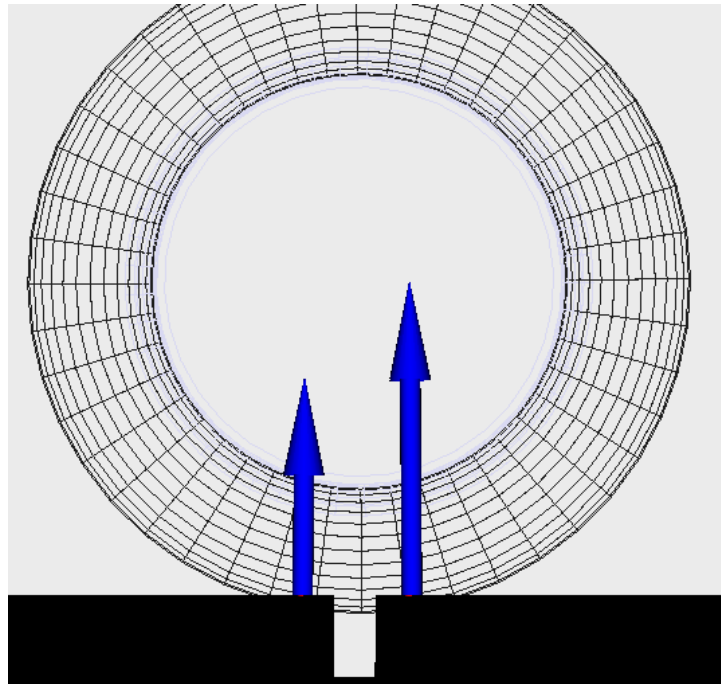

Figure 1.26. Track beam joint

Special track deviations (STD) are geometric deviations of beams from ideal state, which cannot be considered as smooth and small irregularities. For example, a beam joint in Figure 1.26 can be considered in UM as a special track deviation only. We consider a plane model of STD only, and the deviations are considered for the driving wheels only, not for the guiding and stabilizing wheels.

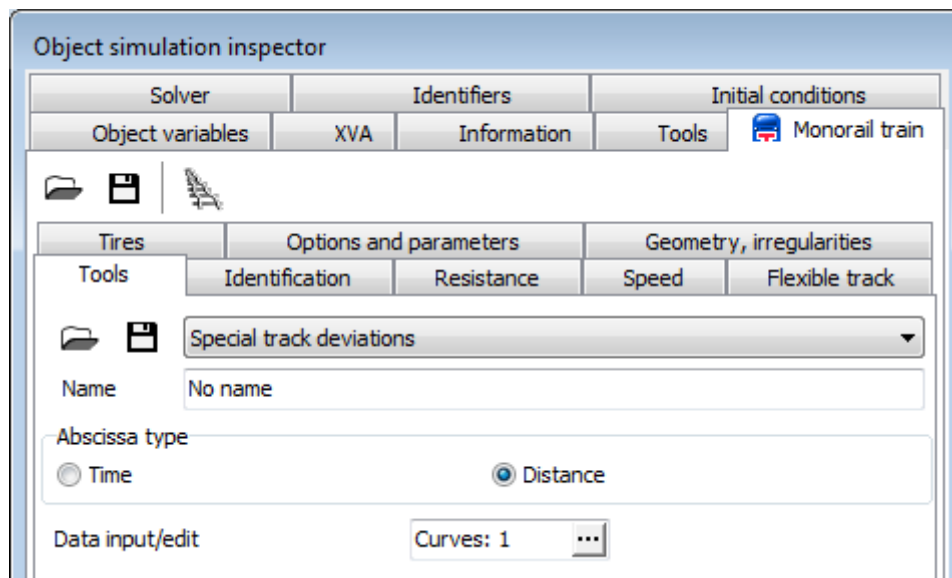



Figure 1.27. Tool for STD description

Plane STD are described by a plane curve with the tool, located on the **Monorail train | Tools** tab of the Object simulation inspector. Select the Special track deviations item of the pull-

down menu and click on the  button to open the curve editor for description of the STD, Figure 1.28.

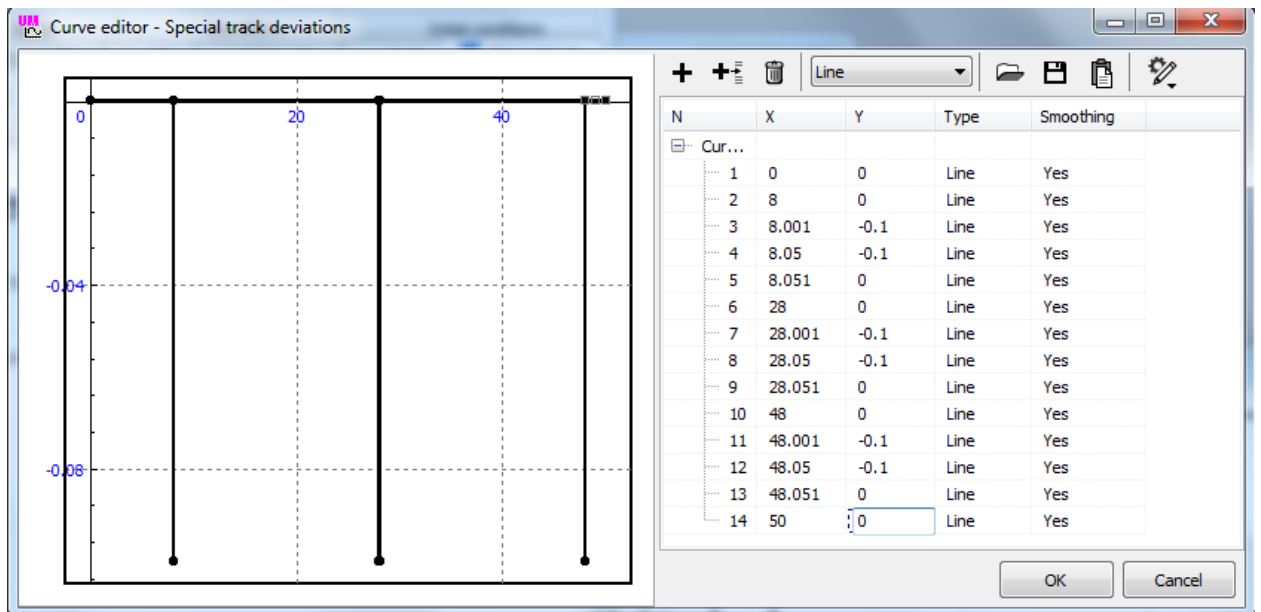



Figure 1.28. STD curve with three beam joints

Use the  button on the **Tools** tab to save the curve as a \*.trp file.

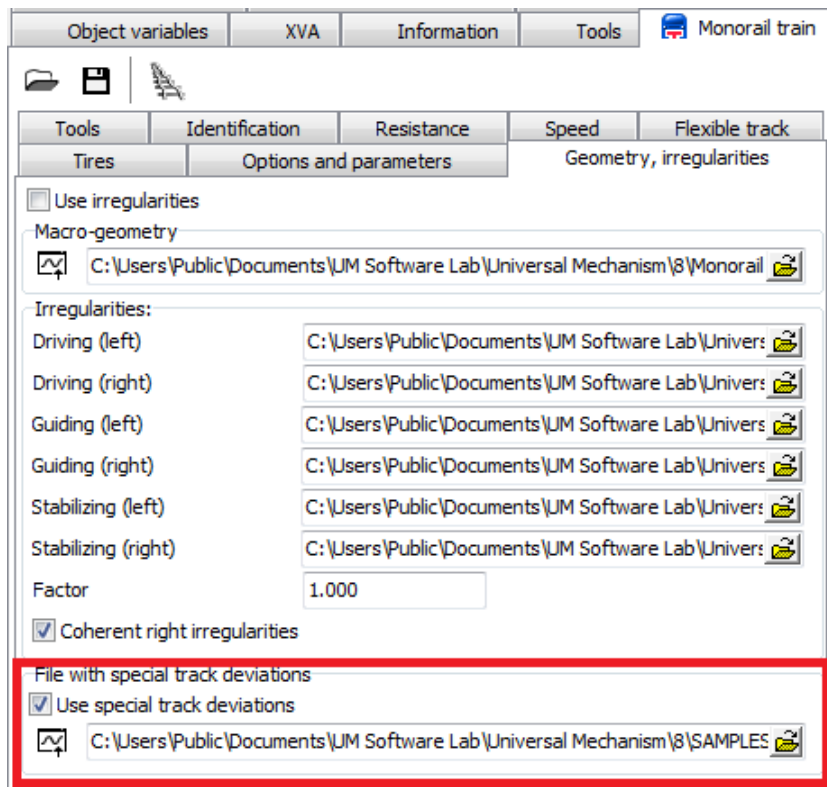



Figure 1.29. Choice of file with STD

To run simulation with a STD curve, select a \*.trp file with the  button and check the **Use special track deviations** option.

The **Use special track deviations** option allows the user to compare promptly simulation results with and without STD.

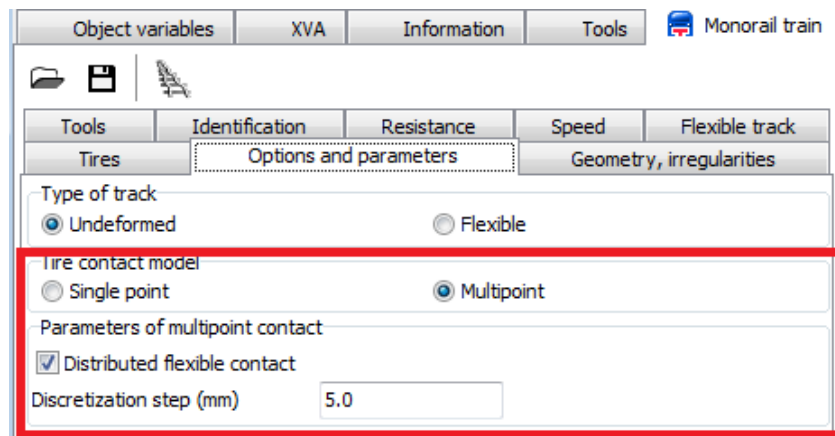

Figure 1.30. Parameters of tire contact model

Tune the tire contact model according to the selected STD. Look at [Chapter 12](#) (file 12\_um\_automotive.pdf), Sect. *Single point and multipoint normal contact models* for detailed description of the tire contact model.

If the **Distributer contact model** option is unchecked, the *discrete point contact* is used, which usually used for rolling up a step. In the case of beam joints it gives wrong simulation results.

**Remark** One additional advantage of use the STD consists in drawing the corresponding deviations in animation window. Usual irregularities are not drawn, and if the user wants to see a short vertical irregularity during the animation, he should describe the vertical irregularity as STD.

## 1.5. Tire models

Models of tire/road interaction forces are considered in details in [Chapter 12](#) file, Sect. *Tyre models*. Parameters describing the models are stored in \*.tr files. The default directory for these files is {UM Data}\monorail\tire. The user may use the built-in **Wizard of tire models** for changing model parameters.

## 1.6. Track models

There are two types of monorail track models: an **undeformed or rigid track** and a **flexible** one. Undeformed track cannot move and fixed relative to the SC0. In the case of a flexible track, it is modeled as a sequence of FE (finite element) Timoshenko beams with the same section. Each of the beams consists of several sections with different length and with different FE mesh. Beams are connected with neighbor ones and with SC0 by linear viscous-elastic force elements of bushing type, Figure 1.31.

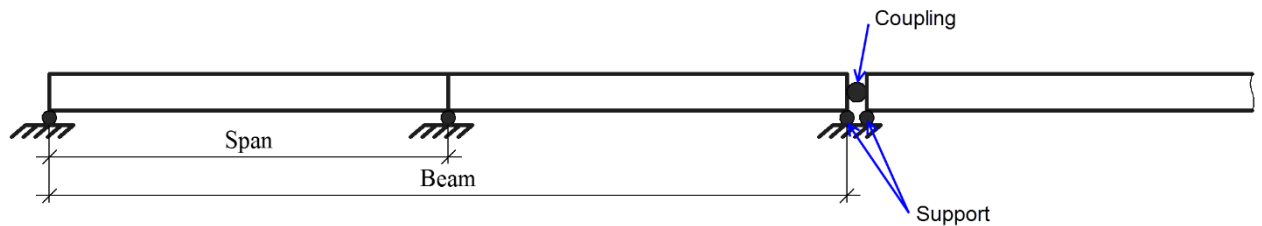

Figure 1.31. Model of a flexible monorail track

You can choose a track model on the tab **Monorail train | Options and parameters**, Figure 1.32.

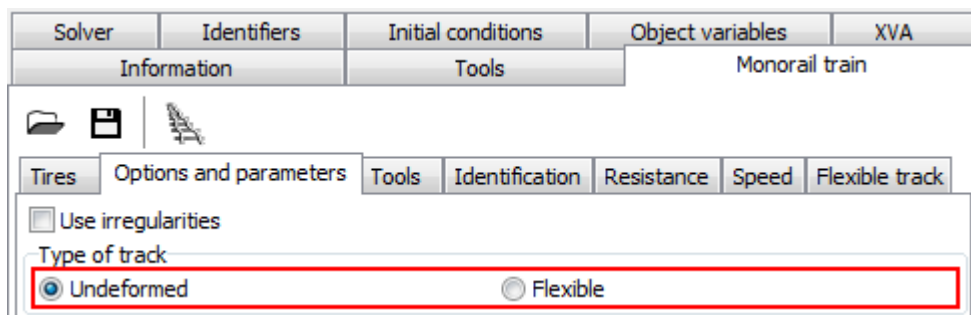

Figure 1.32. Type of monorail track

### 1.6.1. Flexible track parameters

The **Flexible track** parameters are described on the corresponding tab and on the **Tools** tab (item *Beam section profile*), see Sect. 1.7.1.3. The **Flexible track** tab includes two groups of parameters **Beams** and **Links**, see Figure 1.33. In the **Beams** group, a sequence of beams is described with the following buttons:

- +** is used to add beam to the list;
- is used to remove selected beam from the list;
- is used to insert beam before the selected one.

The following parameters relate to the flexible track:

*No.* is the beam sequence number;

*L* is the total length, i.e. the length of the beams from the first one to the current one;

*Span lengths.* The following syntax is used:

SpanLength1[RepeatCount1], SpanLength2[RepeatCount2], ...;

*FE count* is the number of FE for a section. The following syntax is used:

FECount1[RepeatCount1], FECount2[RepeatCount2], ...;

*No. support* assigns indices of force elements from the set **Support**. The force elements connect beams with SC0. Syntax is

SupportID[RepeatCount1], SupportID[RepeatCount2], ...;

*No. coupling* is the index of force element from the **Coupling** set connecting the beam with the next one. Set **-1** if are beams not coupling.

*Damping ratio* is the damping parameter for a beam; this parameter is equal to the damping ratio related to the first mode of the beam.

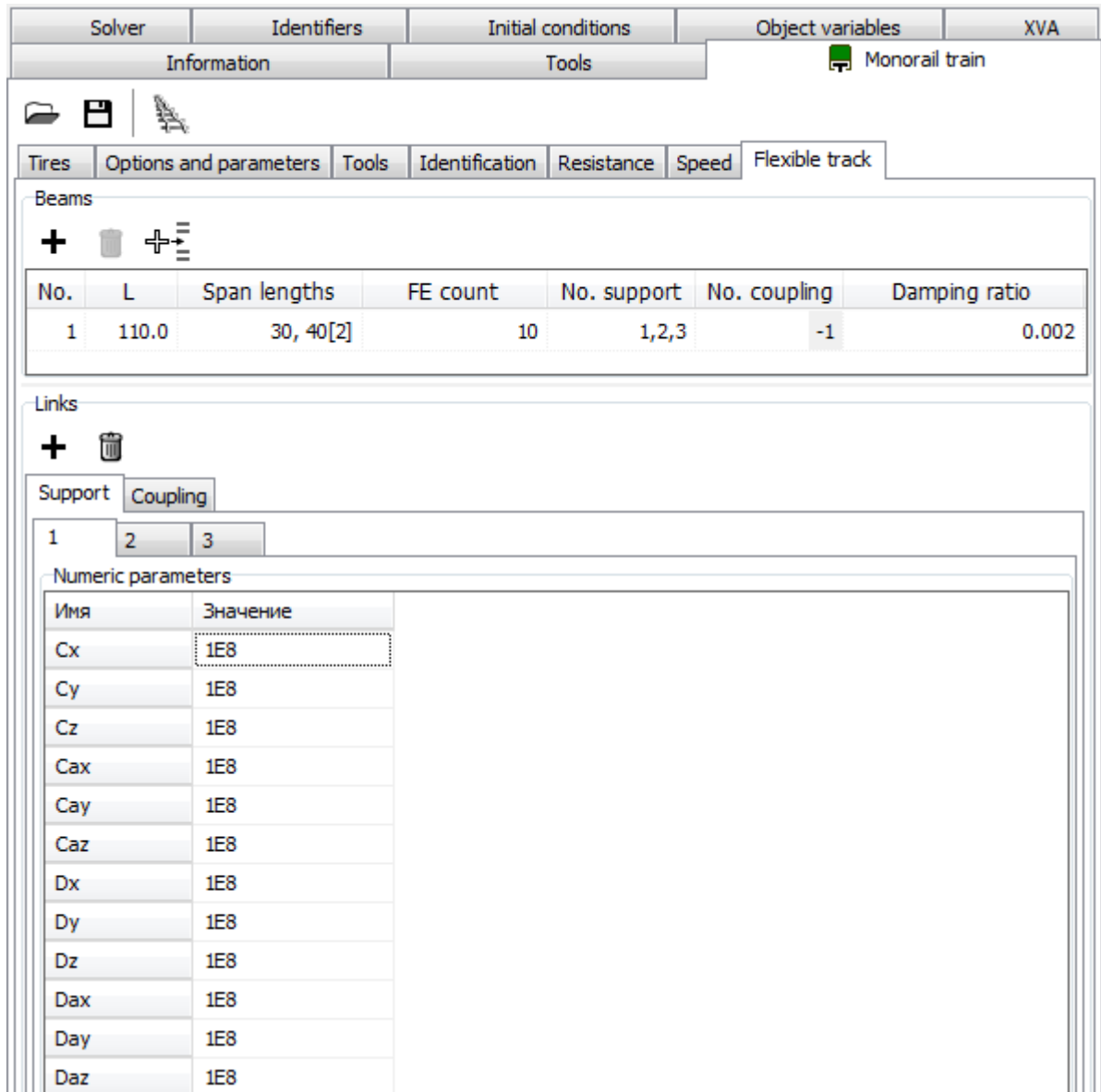

Figure 1.33. Flexible track tab

The buttons Add link **+** and Remove selected link **🗑** are used for development of **Support** and **Coupling** force lists.

## 1.7. Simulation of monorail dynamics

### 1.7.1. Preparing for simulation

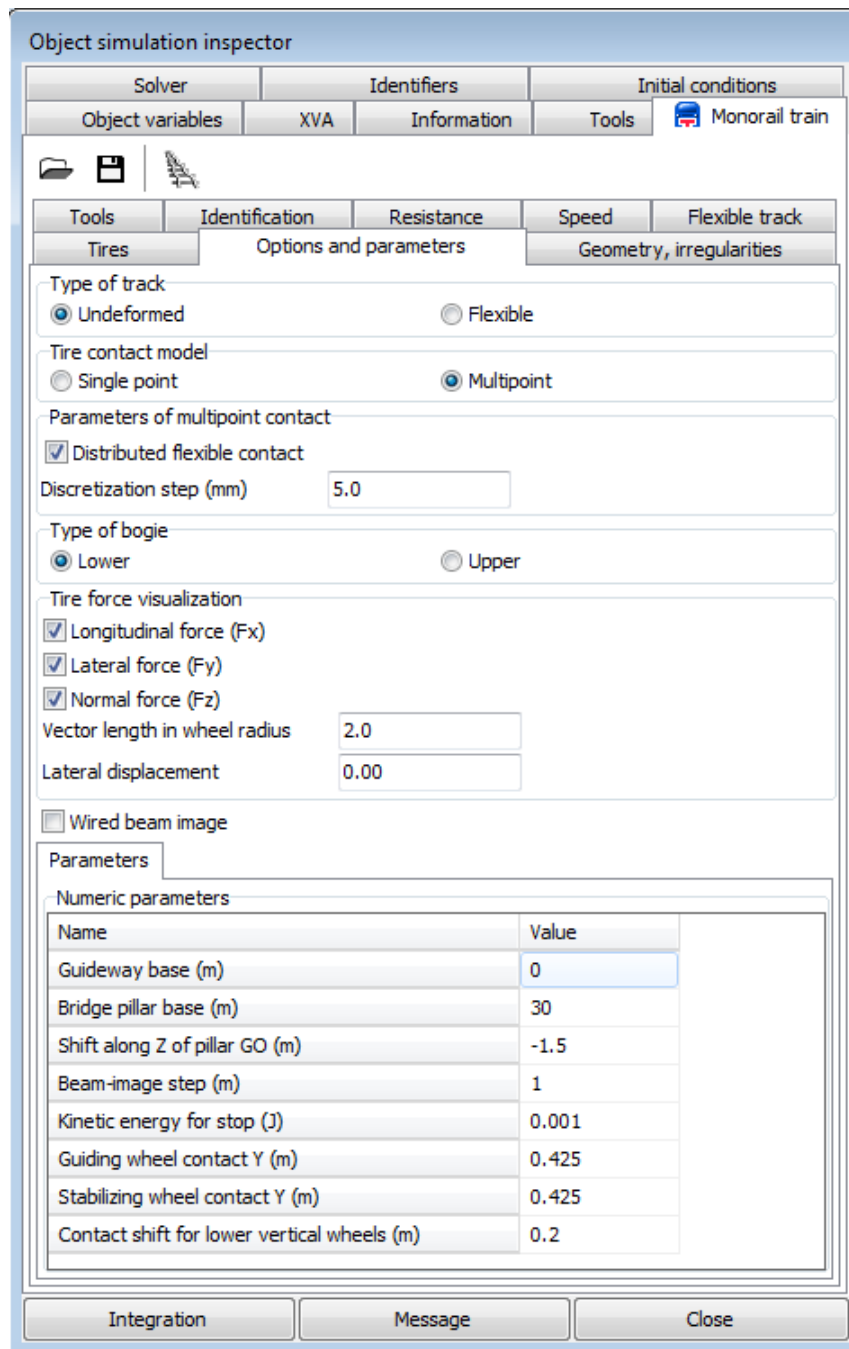

Figure 1.34. Object simulation inspector

The most part of the monorail specific data is entered and modified with the help of the **Monorail train** tab in the **Object simulation inspector**, Figure 1.34. Use the **Analysis | Simulation...** menu command of the **UM Simulation** program to open the inspector. The data can be saved in monorail vehicle configuration files \*.mrt. Use the buttons on the tab to read/write data.

The monorail configuration data is saved automatically in the *last.mrt* file if the **Monorail train configuration** key is on in the options of the **UM Simulation** program, Figure 1.35. Use the **Tools | Options...** menu command to call this window.

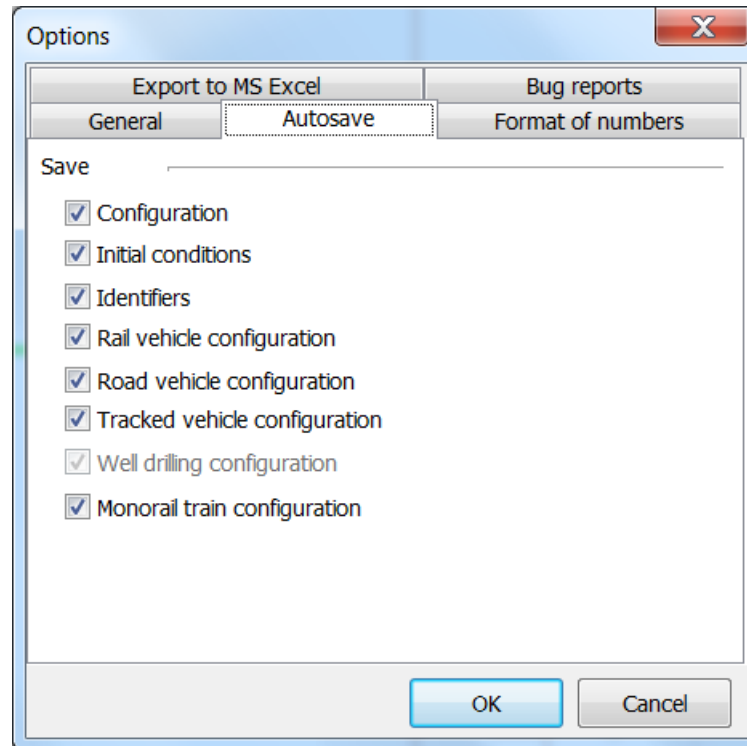



Figure 1.35. Options of **UM Simulation** program

General information about **UM Simulation** program and its tools are concentrated in [Chapter 4](#).

The user should follow some definite steps to make a new created monorail model ready for simulation.

1. Create a monorail train model in **UM Input** program.
2. Run the **UM Simulation** program.
3. Assign tire models to the wheels on the **Monorail train | Tires** tab. If necessary, create new tire models.
4. Assign a preliminary created file of macro-geometry by the , Figure 1.34. Use the  button to view/modify the macro-geometry.
5. If necessary, check the option **Use Irregularities** and assign irregularity files, Figure 1.34. The **Factor** increases (<1) or decreases (>1) assigned irregularities.
6. Set the guideway structure geometrical parameters, Figure 1.34:
  - **Guiding wheel contact Y** (m) – a half of guiding beam width on the level of guiding wheels.
  - **Stabilizing wheel contact Y** (m) – a half of guiding beam width on the level of stabilizing wheels.
  - **Guideway base** (m) – distance between two parallel guiding beams, has a visual effect only.

- **Bridge pillar base (m)** – distance between bridge pillars in longitudinal direction, has a visual effect only.
  - **Shift along Z of pillar go (m)** allows matching the pillar vertical position.
  - **Beam image step (m)** is the discretization step of the longitudinal beam image. Decrease of this parameter makes smother the beam curve in animation window, has a visual effect only.
7. Set the **Kinetic energy for stop** parameter (Figure 1.34), which is used in equilibrium simulation (speed mode  $v=0$ ).

### 1.7.1.1. Identification of longitudinal velocity control

Use the **Monorail train | Identification** tab of the **Object simulation inspector** to identify the *longitudinal velocity control* parameters. Select the ‘Control V’ data type in the drop-down menu

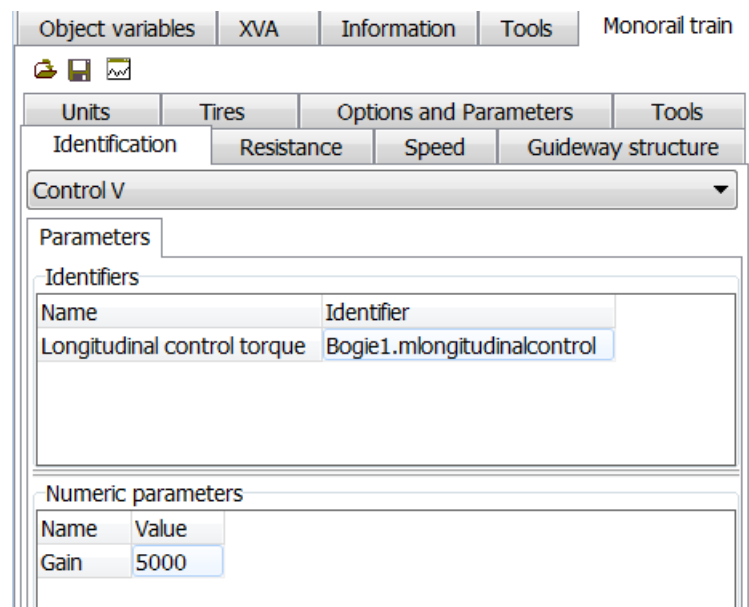

Figure 1.36. Identification of longitudinal velocity control parameters

Identification of the longitudinal velocity control parameters of the model requires selecting of one identifier, Sect. 1.3.6, Figure 1.36:

- Longitudinal control torque as well as one numeric values
- Control gain

Double click be the left mouse button on the corresponding table row to assign a model identifier. Use the direct input to set the gain value.

The control of the longitudinal velocity is realized to the proportional control law

$$M = -K(v - v_d)$$

where  $M$  is the torque (the value of the torque identifier),  $K$  is the gain,  $v$  is the current velocity of the vehicle, and  $v_d$  is the desired velocity, which can be both constant and some function of time.

### 1.7.1.2. Creating longitudinal velocity functions

Use the **Monorail train | Tools** tab of the **Object simulation inspector** to specify the desired *longitudinal velocity* functions.

Using this interface the user specifies a dependence on time or distance of the desired longitudinal speed, Figure 1.37.

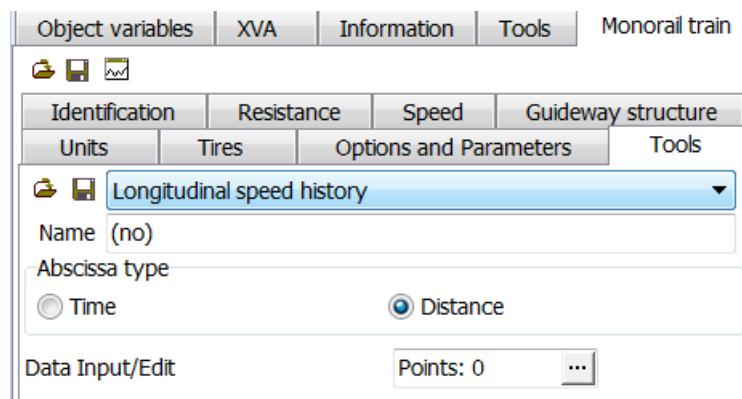



Figure 1.37. Interface for functions of time and distance

The function is a set of points with a possible spline smoothing. To set the function, the user calls the curve editor by clicking the  button.

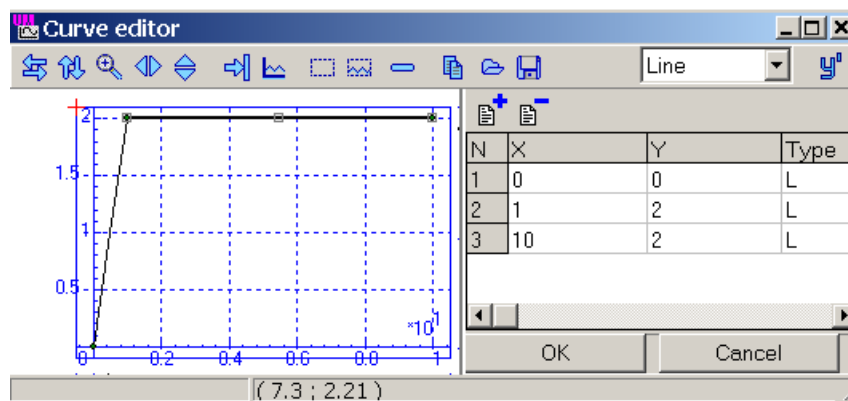



Figure 1.38. Setting functions with the curve editor

Use the   buttons to read/save data from/to file.

**Remark.** If initial speed is zero, dependence of the speed on time must be used (not on distance).

### 1.7.1.3. Creating beam section profile

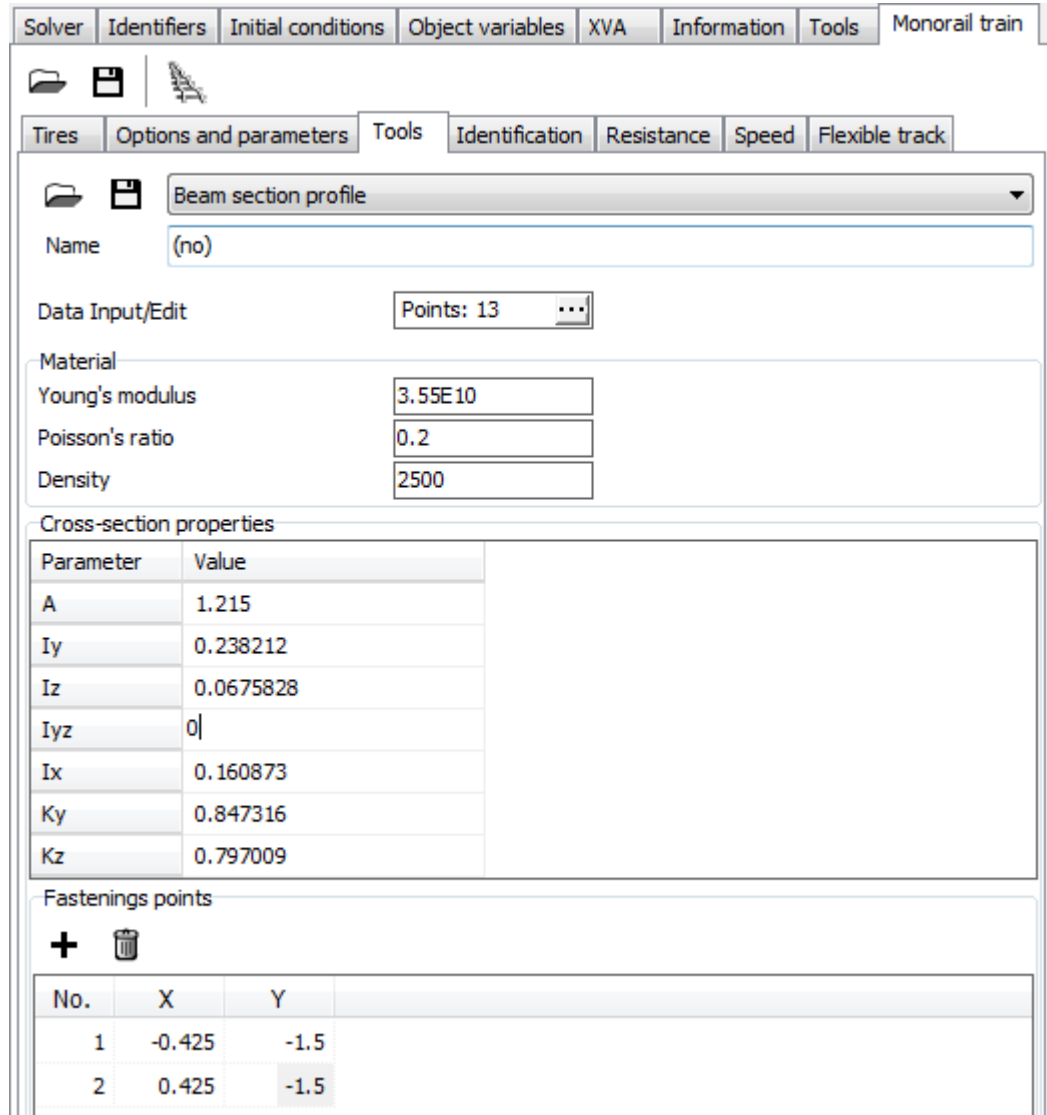

Figure 1.39. Tool for setting beam section

Use the **Monorail train** | **Tools** tab of the **Object simulation inspector** to specify the desired guiding *Beam section profile*, Figure 1.39. Click on the button to open the Curve editor. The profile is described by a closed line be a set of points, see Figure 1.40.

In the case of a flexible track, Sect. 1-25, the beam parameters **Young's modulus**, **Poisson's ratio** and **Density** are set in the **Material** group, as well as geometric section parameters are specified in then **Cross-section properties** group, Table 1.1.

In the **Fastenings points** group, fastenings points of the beam to the pillar can be define. The fastening points are defined in the local system of coordinates of the beam cross-section, see Figure 1.40. If the fastening points are not defined, then are assigned automatically depending on the beam type according to Figure 1.41. The buttons Add point and Remove selected point are used for development of Fastenings points list.

Table 1.1

**Monorail beam cross-section parameters**

Parameter	Description
$A$	Cross-section area
$I_y$	Moment of inertia relative to Y axis
$I_z$	Moment of inertia relative to Z axis
$I_{yz}$	Product of inertia
$I_x$	St. Venant torsion constant
$k_y$	Shear correction factor in principal planes Y
$k_z$	Shear correction factor in principal planes Z

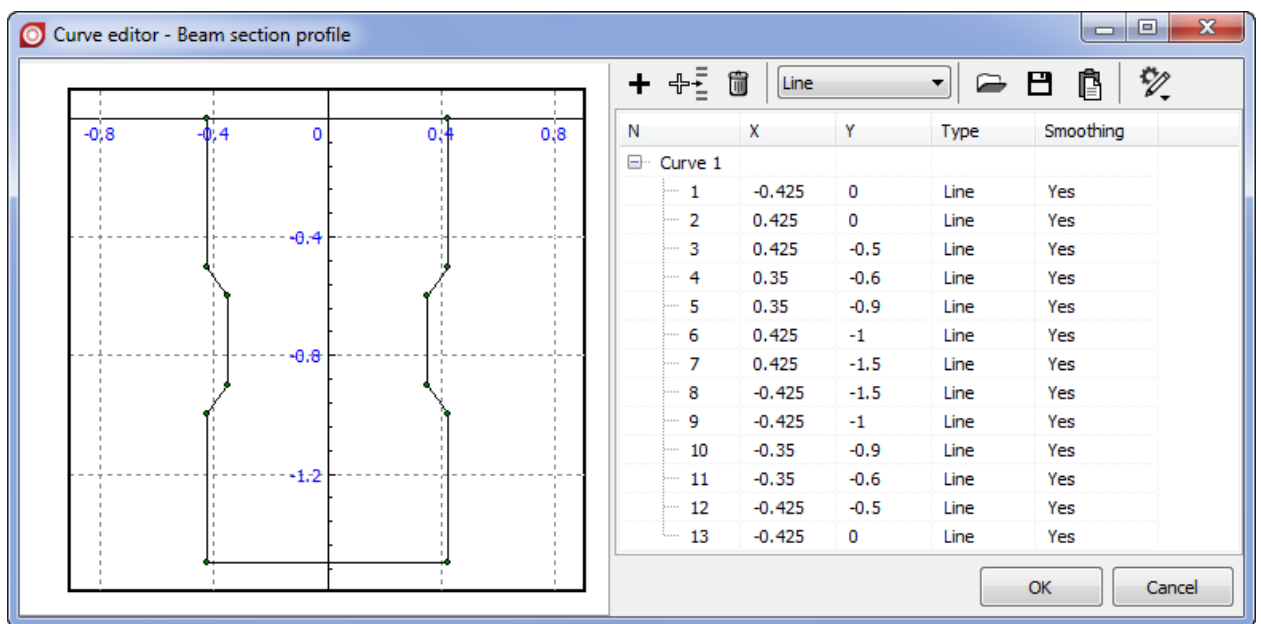

Figure 1.40. Beam section description

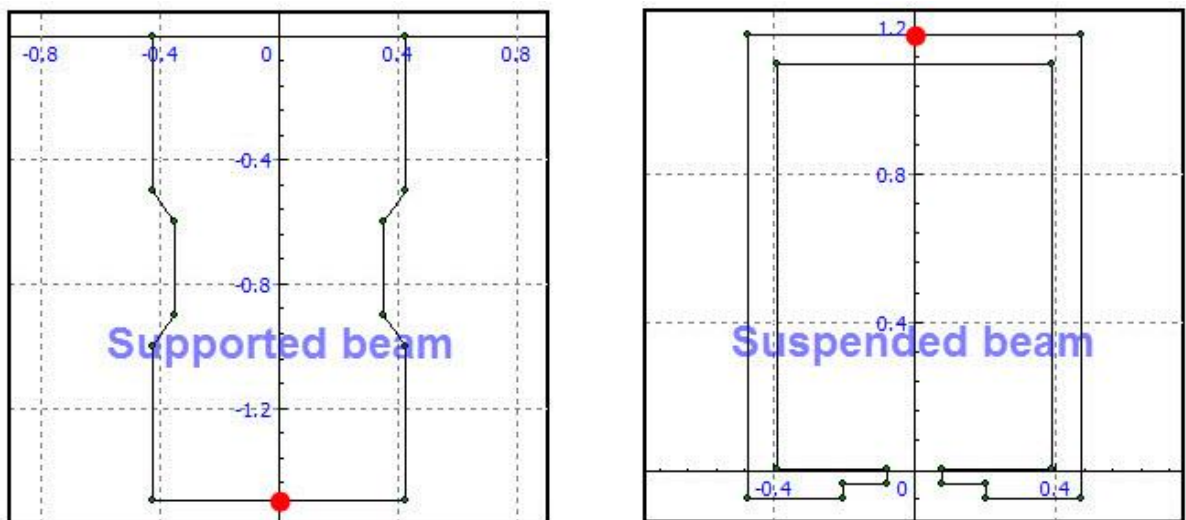

Figure 1.41. Location of default fastening points for different types of monorail beams

### 1.7.2. Modes of longitudinal motion of monorail

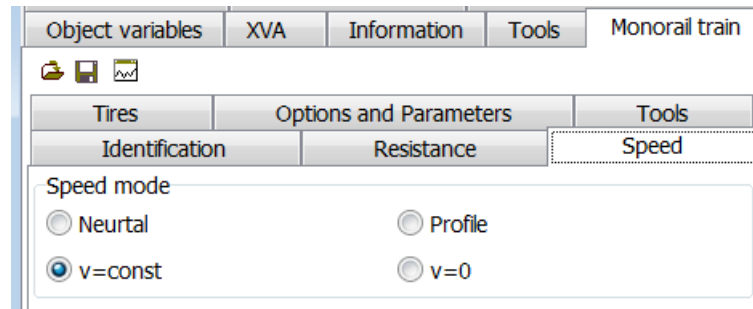

Figure 1.42. Longitudinal motion modes

Modes of longitudinal motion of the monorail are set on the **Monorail train | Speed** tab of the inspector.

#### 1.7.2.1. Neutral

In this mode the initial speed value is set by the **v0** identifier, Figure 1.43. The speed decreases due to resistance forces.

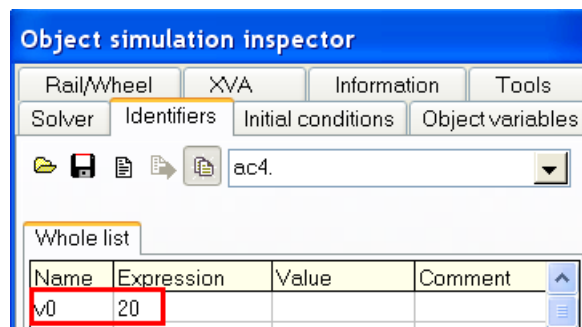

Figure 1.43. Identifier of speed

#### 1.7.2.2. v=const



Constant speed mode. The nearly constant value of the vehicle speed is supported automatically by the torque applied to the driving wheel, see Sect. 1.3.6, 1.7.1.1

$$M = -K(v-v_0),$$

where  $v_0$  is the desired speed,  $v$  is the current speed, and  $K$  is the amplifier.

In this mode the desired speed value is set by the **v0** identifier, Figure 1.43.

### 1.7.2.3. Profile

The speed is controlled according to a dependence on a time or distance. The control force is similar to that in the previous mode ( $v=const$ ). The   buttons are used for reading previously created profiles (Sect. 1.7.1.2) and for saving the current curve.

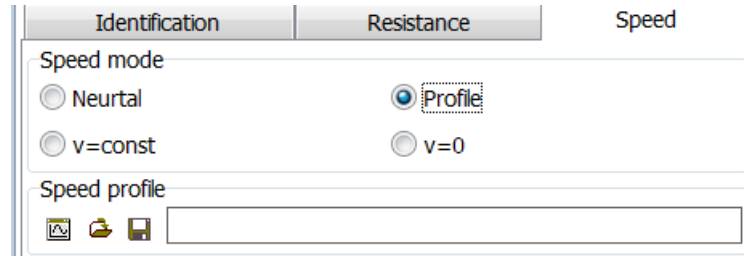

Figure 1.44. Speed profile mode

### 1.7.2.4. $v=0$

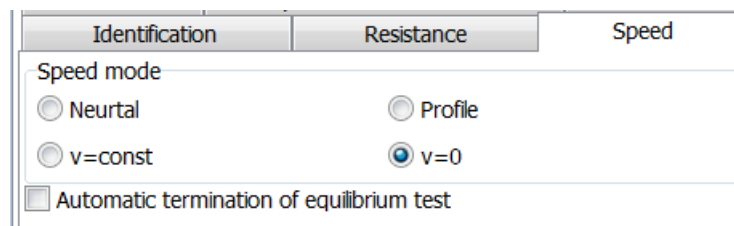

Figure 1.45. Zero speed test

Zero velocity mode.

If the key ‘**Automatic termination of equilibrium test**’ is checked, the simulation runs until the kinetic energy decreases to the minimal value specified by the user, Sect. 1.7.1, the parameter **Kinetic energy for stop**. After success of the test, the program automatically accepts the coordinate values as standard ones and stored static deflections of tires and static tire loads, Figure 1.46. It is recommended to run this equilibrium tests before other simulations.

If the key ‘**Automatic termination of equilibrium test**’ is **not** checked, automatic actions are skipped. In this simulation, the user can e.g. apply periodic excitations to get the system response.

XVA Information Tools Monorail train

Tires Options and Parameters Tools Identification Resistance Speed

Combined slip

Set of tire models

c:\users\public\documents\um software lab\universal mechanism\7\tire\  
 c:\users\public\documents\um software lab\universal mechanism\7\tire\  
 c:\users\public\documents\um software lab\universal mechanism\7\tire\

Wheel	Model	Stat. load	Deflection
monorail vehicle.Bogie1.DriveTire_FL	fialamrdrive04	17.93kN	35.9mm
monorail vehicle.Bogie1.DriveTire_FF	fialamrdrive04	17.93kN	35.9mm
monorail vehicle.Bogie1.DriveTire_RI	fialamrdrive04	17.93kN	35.9mm
monorail vehicle.Bogie1.DriveTire_RI	fialamrdrive04	17.93kN	35.9mm
monorail vehicle.Bogie1.StabTire_L	fialamr_guide03	3.25kN	10.0mm
monorail vehicle.Bogie1.StabTire_R	fialamr_guide03	3.25kN	10.0mm
monorail vehicle.Bogie1.GuideTire_FL	fialamr_guide03	3.25kN	10.0mm
monorail vehicle.Bogie1.GuideTire_FL	fialamr_guide03	3.25kN	10.0mm
monorail vehicle.Bogie1.GuideTire_R	fialamr_guide03	3.25kN	10.0mm
monorail vehicle.Bogie1.GuideTire_R	fialamr_guide03	3.25kN	10.0mm
monorail vehicle.Bogie2.DriveTire_FL	fialamrdrive04	17.93kN	35.9mm
monorail vehicle.Bogie2.DriveTire_FF	fialamrdrive04	17.93kN	35.9mm
monorail vehicle.Bogie2.DriveTire_RI	fialamrdrive04	17.93kN	35.9mm
monorail vehicle.Bogie2.DriveTire_RI	fialamrdrive04	17.93kN	35.9mm
monorail vehicle.Bogie2.StabTire_L	fialamr_guide03	3.25kN	10.0mm
monorail vehicle.Bogie2.StabTire_R	fialamr_guide03	3.25kN	10.0mm
monorail vehicle.Bogie2.GuideTire_FL	fialamr_guide03	3.25kN	10.0mm
monorail vehicle.Bogie2.GuideTire_FL	fialamr_guide03	3.25kN	10.0mm
monorail vehicle.Bogie2.GuideTire_R	fialamr_guide03	3.25kN	10.0mm
monorail vehicle.Bogie2.GuideTire_R	fialamr_guide03	3.25kN	10.0mm

Figure 1.46. Tire static deflections and loads

### 1.7.3. Monorail train specific variables

#### 1.7.3.1. Tire/road contact variables

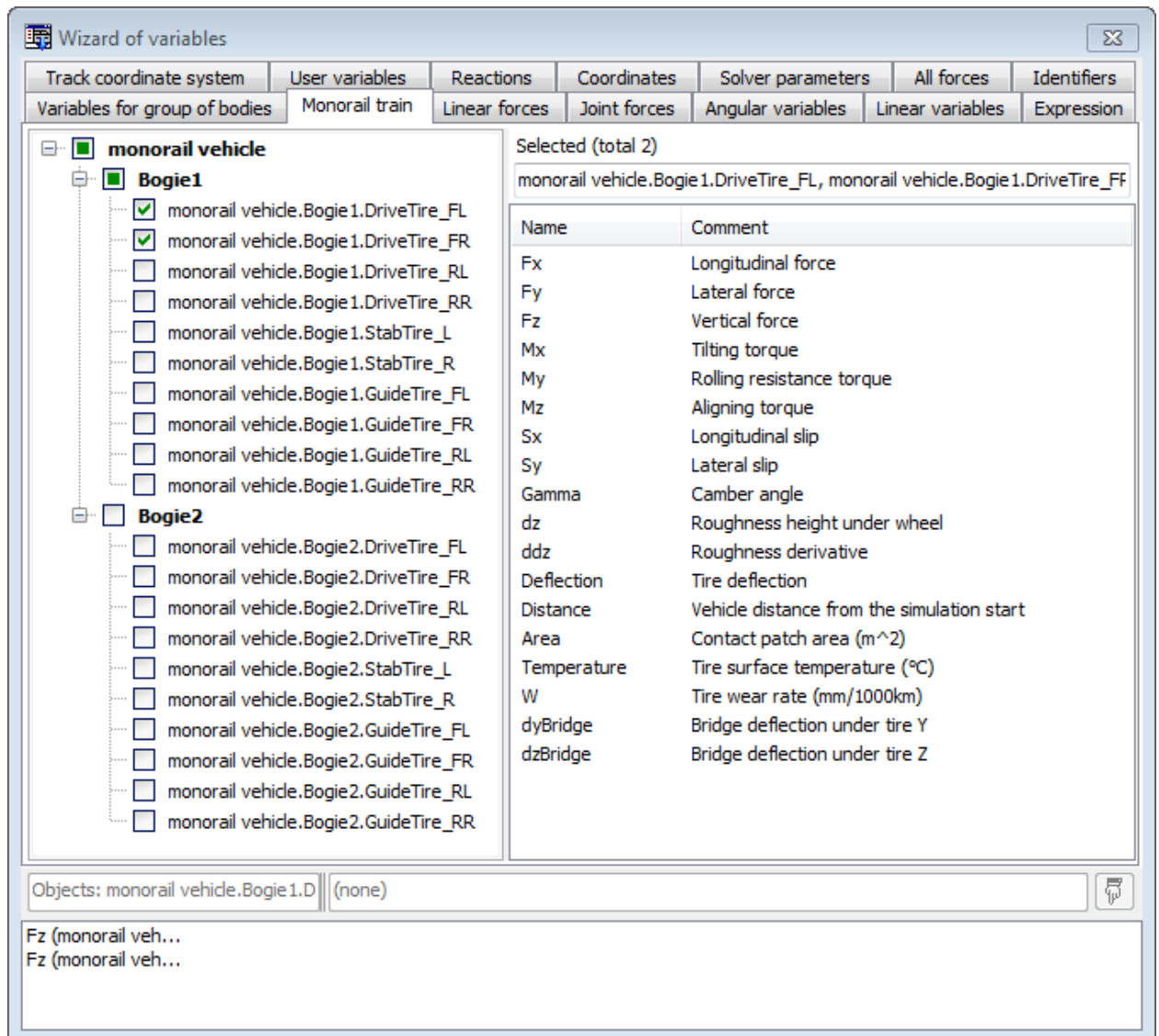

Figure 1.47. Variables related to tire/beam interaction

Variables related to the tire/beam interaction are available on the **Monorail train** tab of the **Wizard of variables**, Figure 1.47. Use the **Tools | Wizard of variables...** menu command to open this window. The **Distance** variable is also available on this tab.

Use other tabs of the wizard to create kinematic and dynamic variables different from the tire variables.

See [Chapter 4](#) to get detailed information about creating variables and their use.

### 1.7.3.2. Kinematic characteristics relative to track system of coordinates

Kinematical variables of bodies should be often projected on the track system of coordinates (TSC). The X-axis of the TSC is the tangent to the guiding beam centerline including the beam vertical slope, Sect. 1.4.3; the Y-axis is perpendicular to the X-axis taking into account the superelevation, Sect. 1.4.2.

Note that axes of the TSC and SC0 in a straight track are parallel, and projections of vectors on these SC are the same.

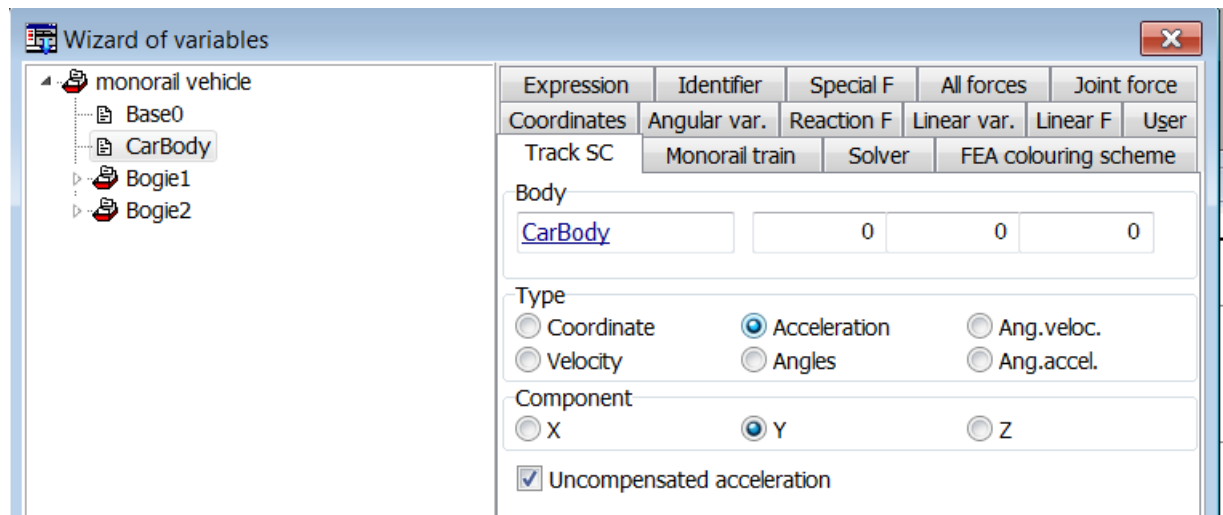

Figure 1.48. Kinematic characteristics of bodies in the track SC

Use the **Track SC** tab of the Wizard of variables to get any kinematic variable in projection of the TSC. To create a variable, perform the following steps:

- select a body in the list in the left part of the wizard;
- select the type of variable: a linear variable (Cartesian coordinates, velocity or acceleration) or an angular variable (angles, angular velocity and angular acceleration);
- set a point in SC of the body, which coordinate, velocity or acceleration should be computed, if a linear variable is selected;
- set an axis of the TSC for projection.

For the lateral component of acceleration, either the uncompensated acceleration or the usual acceleration is selected (Figure 1.48).

## 1.8. Simulation of track as FEM subsystem

Some parts of a track can be simulated as FEM subsystems if UM FEM/Monorail track presents in UM Configuration (see Figure 1.49). In this chapter, the features of description and simulation of such models are presented.

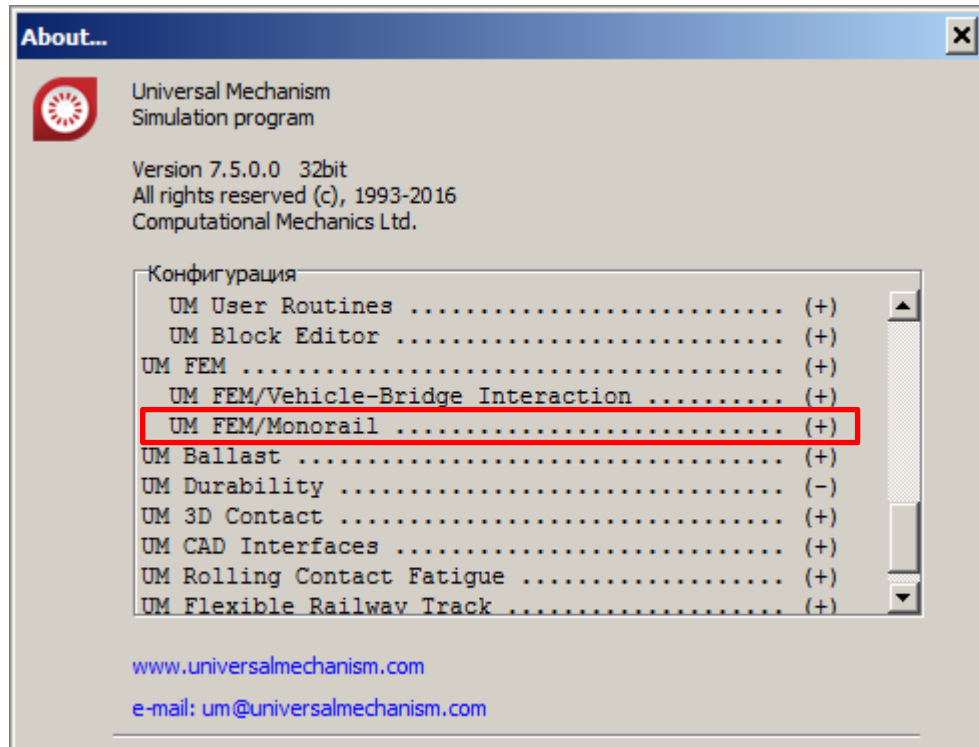

Figure 1.49. Window “About...”: UM FEM/Monorail tool is available

### 1.8.1. Development of FEM subsystem

A FEM subsystem is created in accordance with [Chapter 11](#). Except monorail track, it can include any parts simulating real construction, for example, supports. In order to **UM** consider the subsystem as monorail track, the subsystem comment should contain key string `@monorail=true@` in any place, no case sensitive (see Figure 1.50). For example, “The subsystem simulates monorail track from 30 to 90 meters `@monorail=true@`”.

Geometry of the FEM subsystem must correspond to the track part that it simulates. In **UM Simulation** program, positions of car wheels are calculated using track macrogeometry data. The FEM subsystem must have such geometry and must be placed so that the wheels go on surface of the subsystem.

Let us consider the recommendations for development of the subsystem and matching its geometry and axis of the track.

Creation of 3D FE model of the track part is advised by dragging plane mesh of a cross-section along a track axis (Figure 1.51). If FEM subsystem has simple form like a straight line or a curve with constant radius, it can be easy put to the required place of track macro profile. Otherwise, the way axis lying on the subsystem surface can be included to the description of a whole macro profile as pointwise curves describing horizontal and vertical profiles (Figure 1.52). Let us consider one of the possible methods of preparing data for these curves.

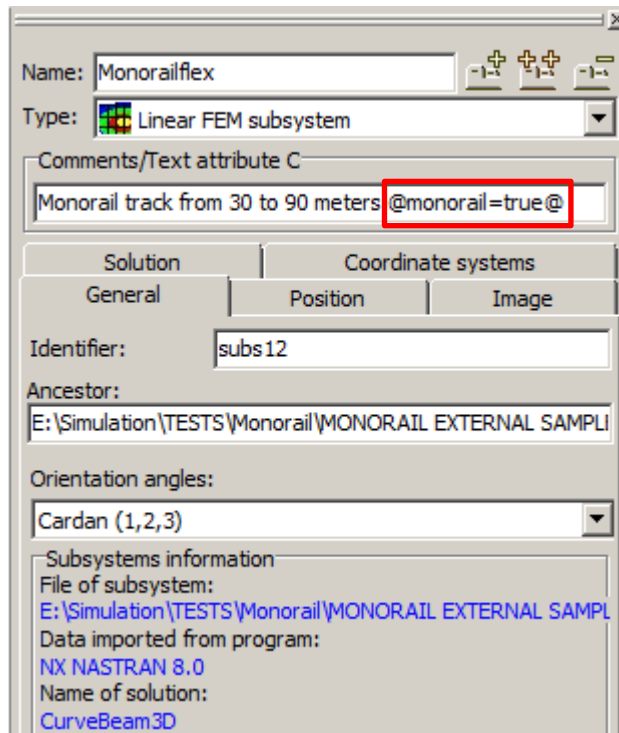

Figure 1.50. Definition Linear FEM subsystem as monorail track via comment string

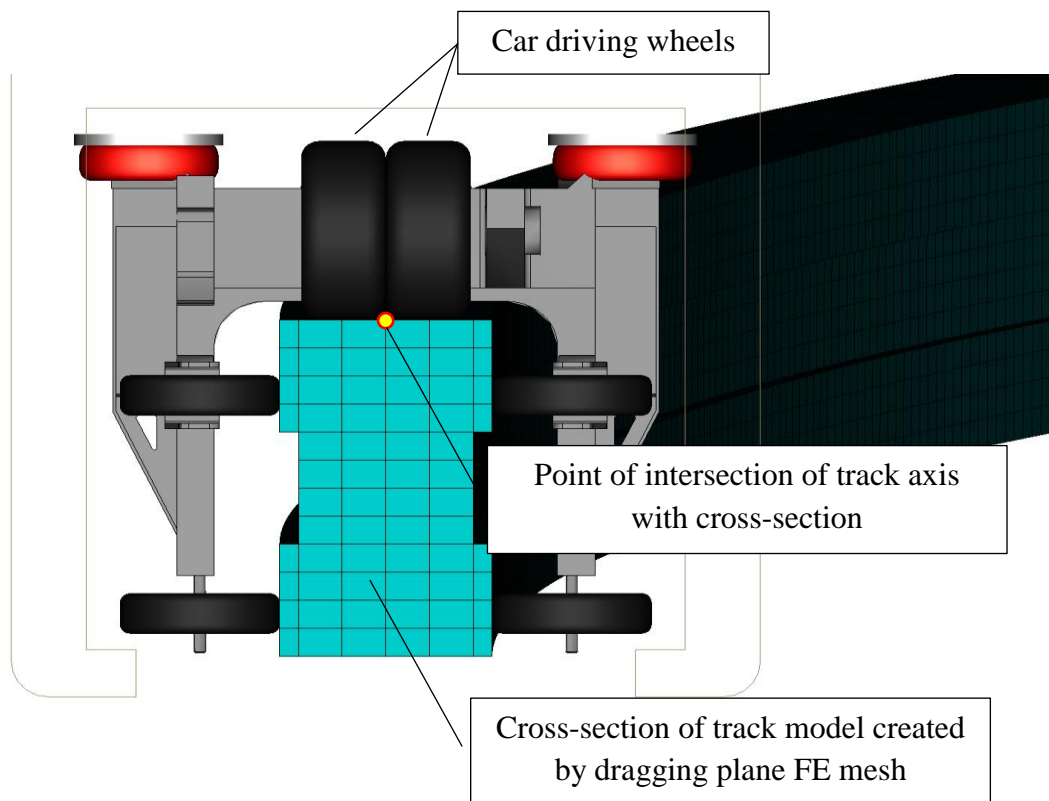

Figure 1.51. Position of the monorail track section relative to the drive wheels

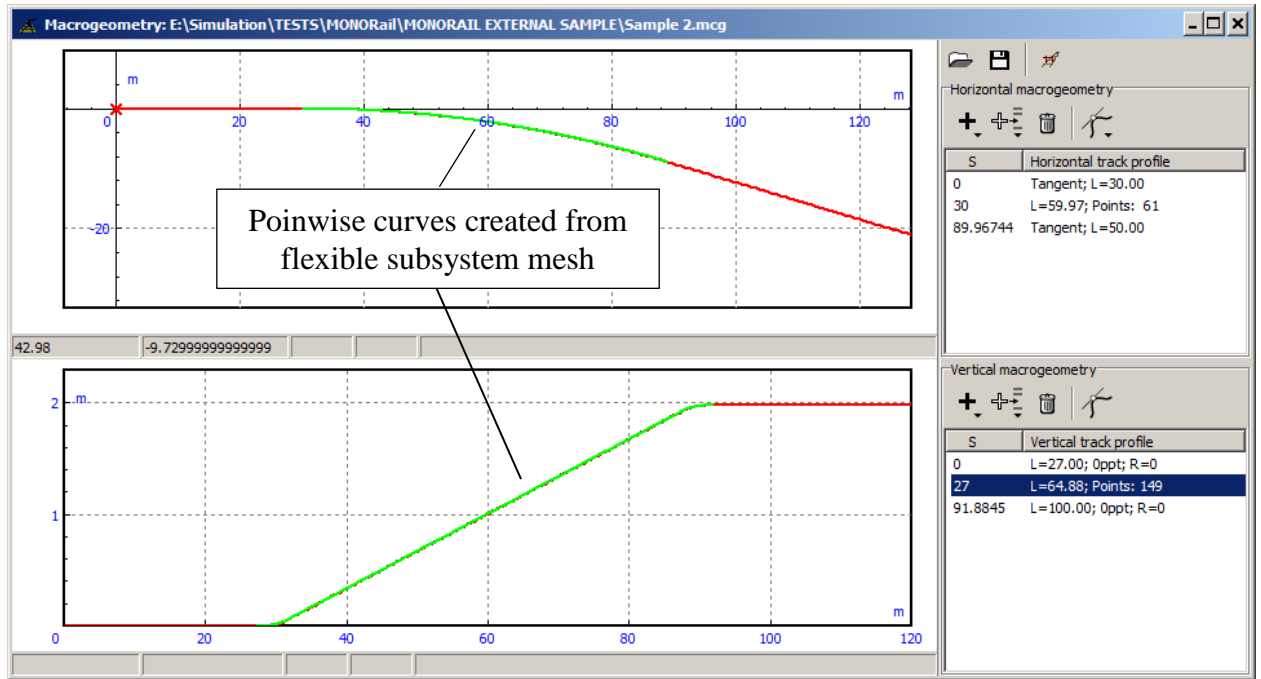



Figure 1.52. Description of macrogeometry including pointwise curves created via finite element mesh of FEM subsystem

1. Load the flexible subsystem and place it in accordance with the position and orientation of simulated part of the monorail track in **UM Input** or **UM Simulation** program (Figure 1.53).

2. Open an animation window and then open the **Selection of nodes** form using **Select FE nodes...** item of the popup menu (Figure 1.54).

3. Push  button and select by mouse two nodes defining the way axis as a line of regular FE mesh of the subsystem. The following rules should be meant for the selection (Figure 1.54, step 3).

- the nodes should belong to an one finite element;
- the selection sequence should correspond to increase of the way coordinate, i.e. the second node should have greater coordinate than the first one.

4. Choice nodes on regular mesh with constant step in meters (Figure 1.54, steps 4, 5).

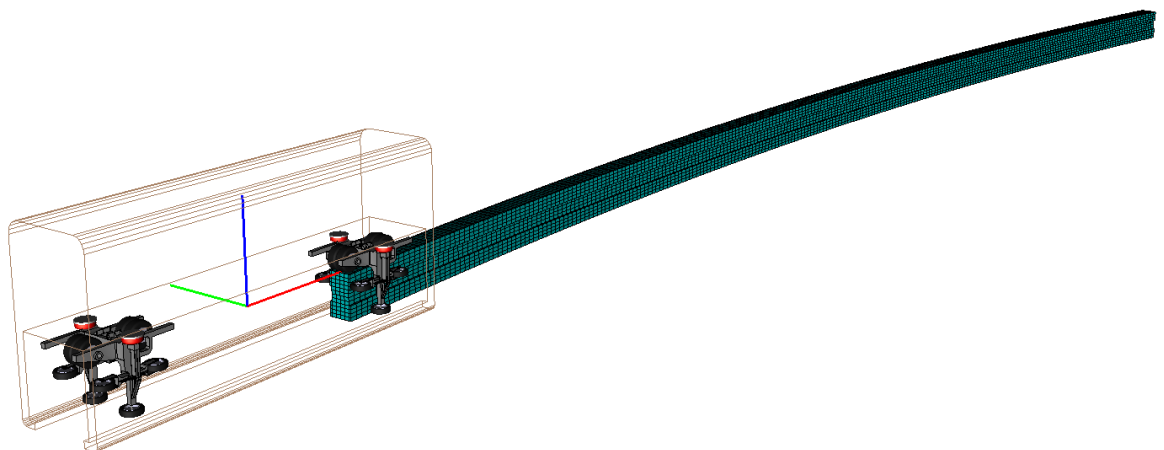

Figure 1.53. General view of the model in animation window

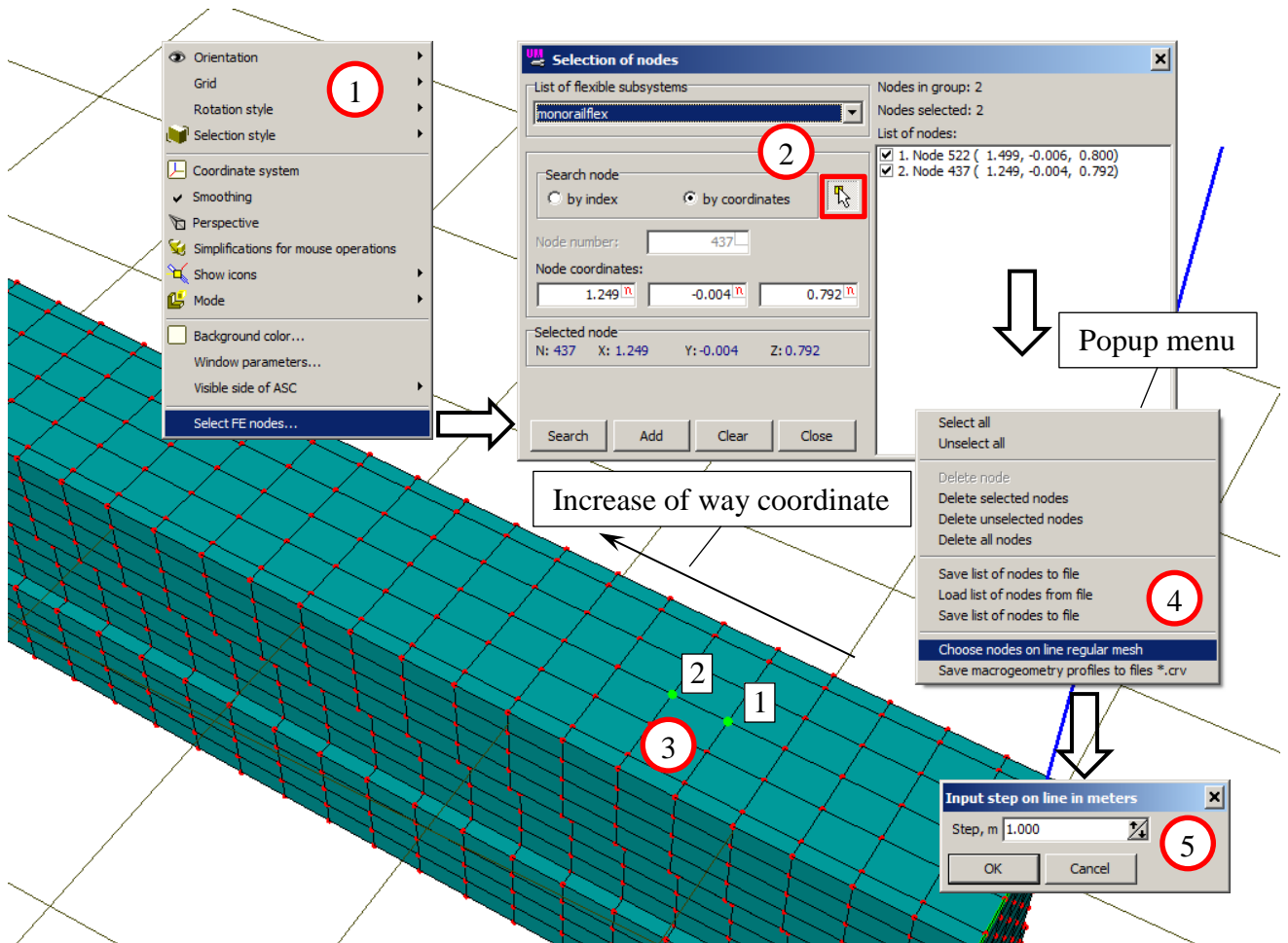

Figure 1.54. Choice of nodes on line of regular mesh of FEM subsystem

If the selection of the nodes was incorrect, the following message is outputted on the screen. In such cases delete all nodes from the list and repeat the selection more carefully.

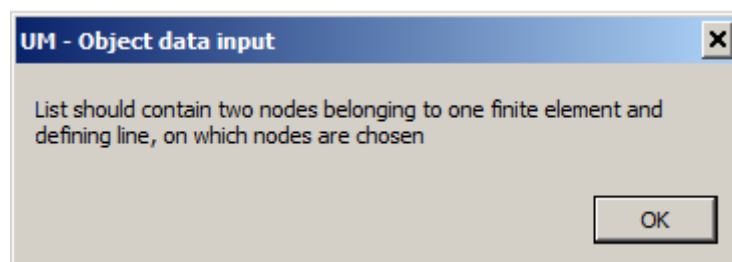

Figure 1.55. Diagnostic message on incorrect choice of nodes

If the selection is correct, the state of the screen will be similar to Figure 1.56.

5. Use the **Save macrogeometry profiles to files \*.crv** item to create the files with horizontal and vertical profiles data. Input file name into the **File name** field of the **Windows** dialog form and push **Save** button. As the result, two files will be created. The strings “horizontal profile” and “vertical profile” will be added to the file names correspondingly. For example, a user inputted “Macrogeometry 5” in the **File name** field. Then **Macrogeometry 5 horizontal profile.crv** and **Macrogeometry 5 vertical profile.crv** will be created.

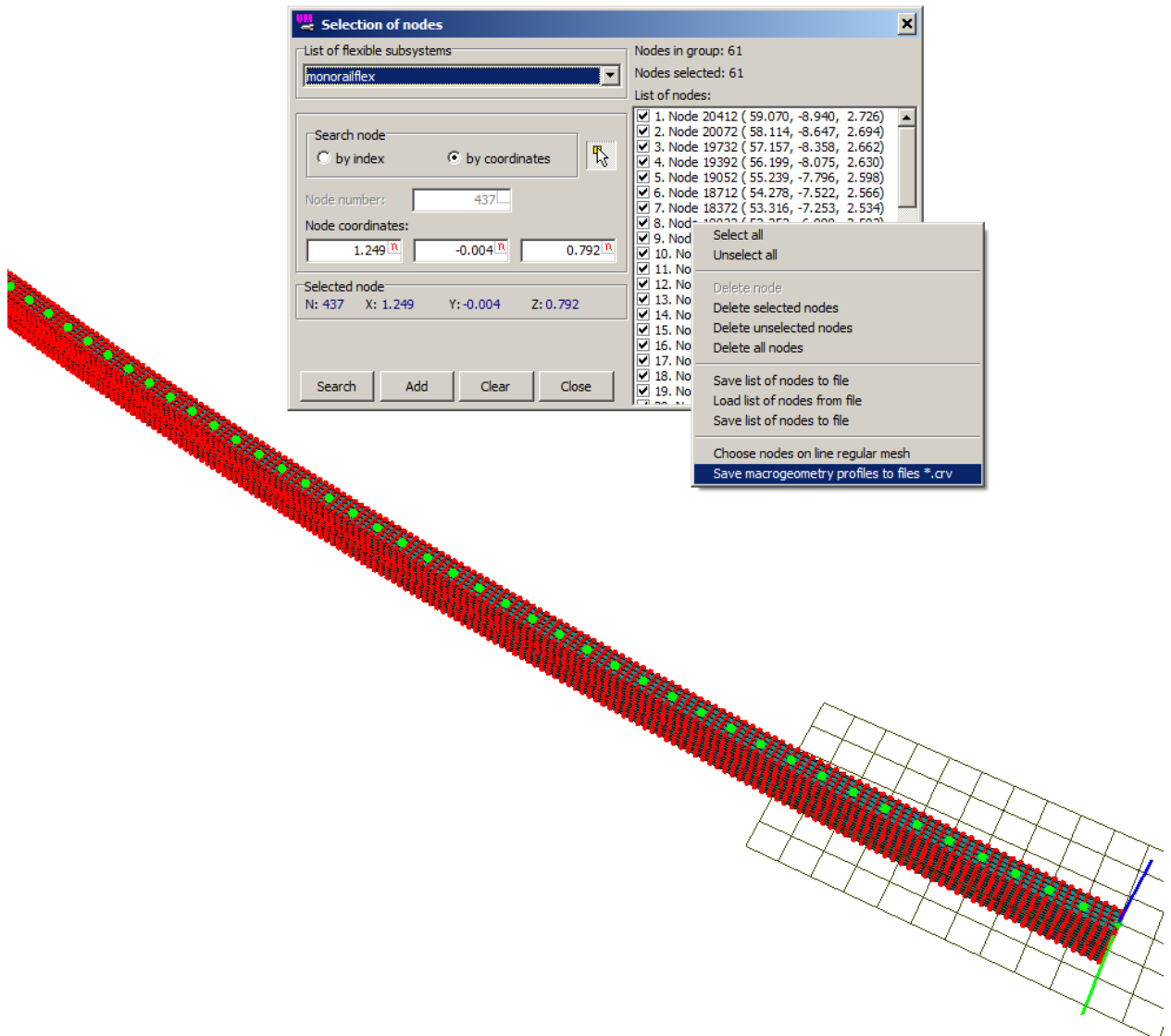





Figure 1.56. General view after choice of nodes on regular mesh

These files should be used for description of a track macrogeometry. Open editor of macrogeometry using main menu item **Tools | Macrogeometry editor... | Railway or monorail track**

... or by  button on the tools panel. Add sections preceding the part simulated by the flexible subsystem. Then the following steps should be carried out.

1. Add a pointwise curve (Figure 1.57, 1-2) and open curve editor (Figure 1.57, 3).
2. Load the curve from the created earlier file by  button, for example, **Macrogeometry 5 horizontal profile.crv** (Figure 1.58).
3. Push **Ok** button and then push **Apply** on **Pointwise curve** form.
4. Repeat these steps for the vertical profile and save macrogeometry to the file by  button on macrogeometry editor form.
5. Choose this file in **Macrogeometry** field on **Monorail train | Options and Parameters** tab of **Object simulation inspector**.

Note. Connecting curves inputted manually can be added to the loaded ones (Figure 1.59). If maximal abscissa value of the resulting curve  $X_{\max}$  is changed, lengths of the neighboring sec-

tions should be corrected. An abscissa value of the start of the curves loaded from the files in the macrogeometry profiles should correspond to the position of the simulated section of the track.

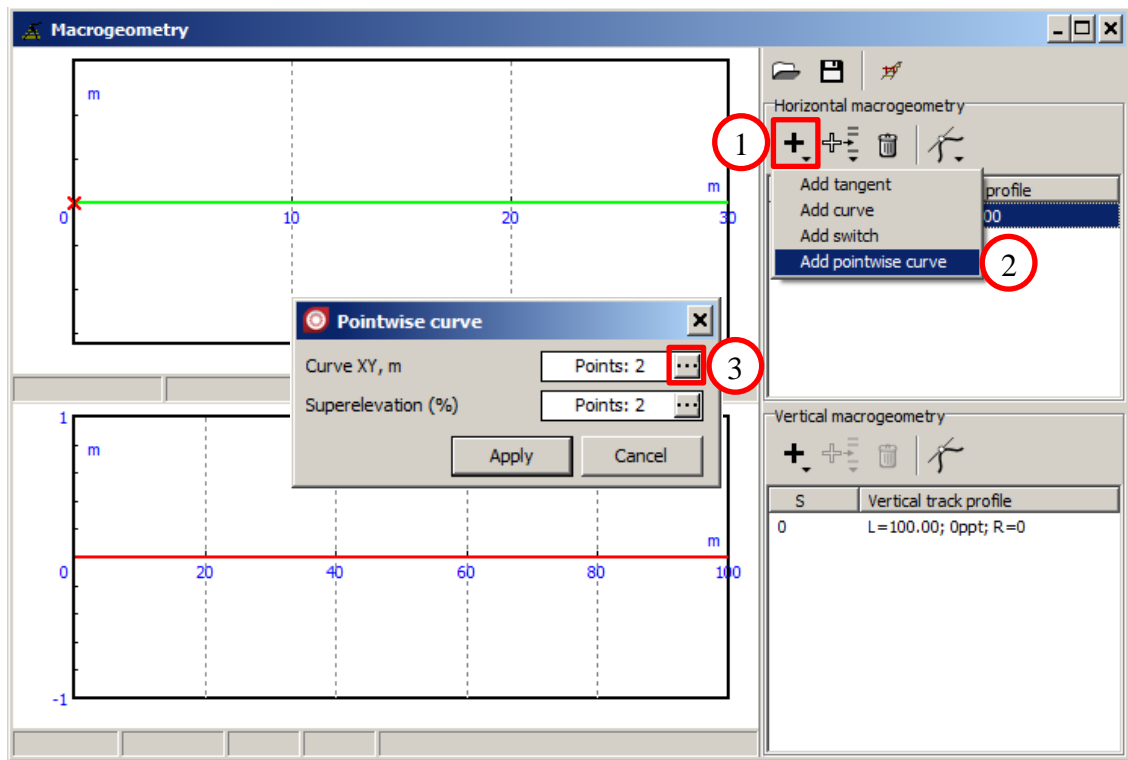

Figure 1.57. Add pointwise curve and start editing

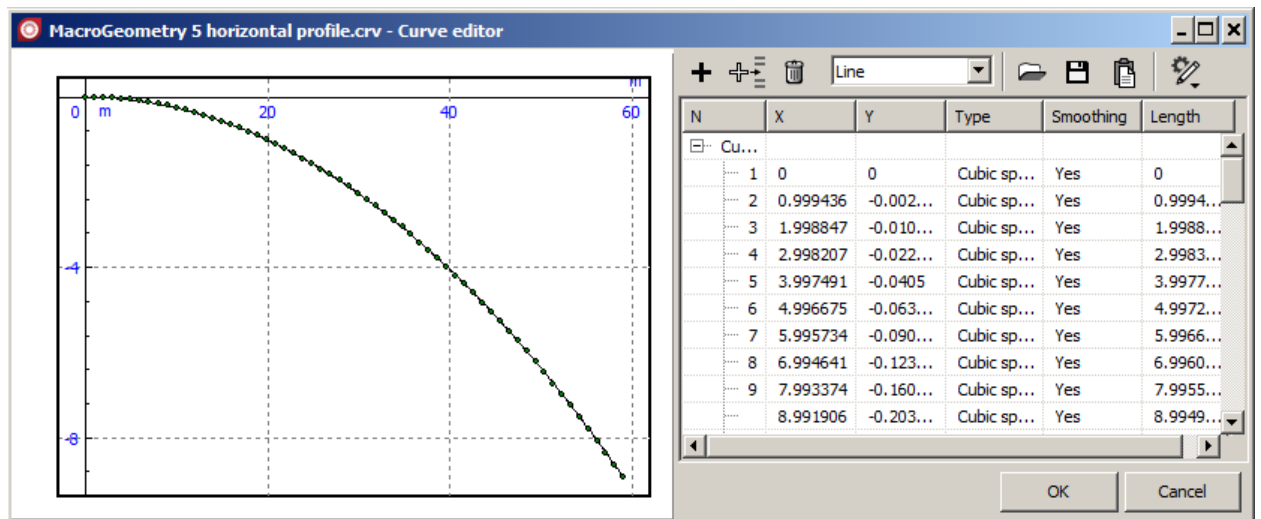

Figure 1.58. General view of loaded curve in editor window

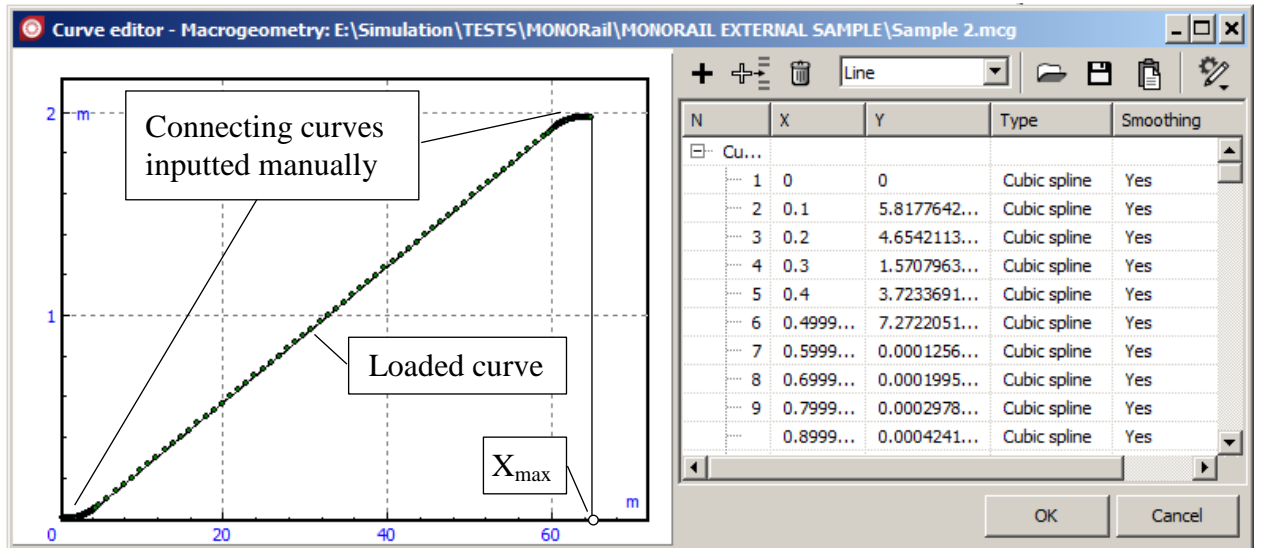

Figure 1.59. Loaded curve is added by connecting curves inputted manually

### 1.8.2. Simulation of vehicle-track interaction

Let us consider the key features of simulation of vehicle-track interaction.

A FEM subsystem simulates a part of a monorail track if value **Type of track** on tab **Monorail train | Options and parameters** is **Undeformed** (see Figure 1.32). Otherwise, the track is simulated as it is described in Sect. 1.6. In this case, the FEM subsystem is present in the model, but it does not interact with the vehicles and they do not influence on each other.

If the flexible subsystem is considered as a monorail track then the **FEM subsystems | Simulation | Monorail** tab appears on the FEM subsystem tab of the **Object inspector** window (Figure 1.60). It includes two tabs: **General** and **Image**.

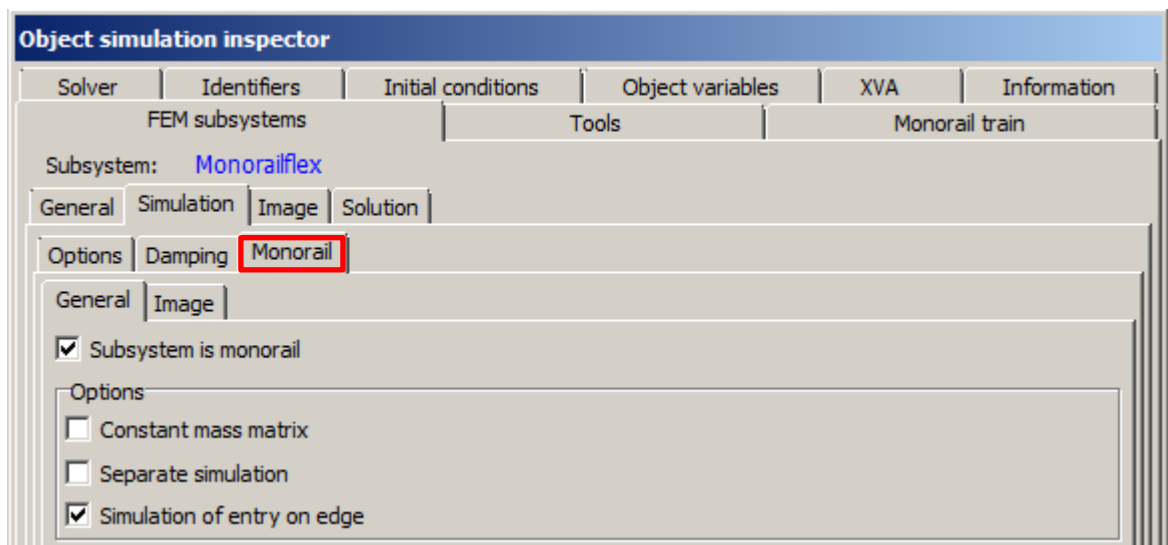

Figure 1.60. Tab **General** of monorail

On tab **General** the following screen components are placed.

- Flag **Subsystem is monorail** switches the flexible subsystem to be considered as a monorail track. It is intended for quick estimation of the influence of track flexibility on vehicle dynamics. A researcher can execute two numerical experiments for comparison of the simulation results. It can be diagrams of displacements, accelerations of vehicle points, force values in force elements and so on. In the first experiment, the flag should be switched on. Results of this experiment should be saved (via copy as static variables, for example) and then the simulation should be repeated with the switched off flag. Difference in the graphs determined by track flexibility.
- Flag **Constant mass matrix** means simulation without recalculations of the mass matrix on every integration step. It can reduce simulation time appreciable if the flexible monorail model has large number of coordinates. Use of the flag is not recommended if this number is less than 100.
- **Separate simulation** flag switches on the simulation mode when flexible displacements and velocities of the monorail track are not taken into account for simulation of vehicle dynamics. However, forces in the wheel-track contacts are applied to the part of flexible track.
- **Simulation of entry on edge** flag turns on gradual application of forces to FEM part when a vehicle runs over its edge. If this flag is switched off, entry of wheels on the edge of FEM track leads to impact, that it instant application of the interaction forces between wheels and the track. This effect is observed for any speed even near to zero. In this case, the forces are approximately equal to vehicle weight distributed between wheels. In order to avoid the impacts, the forces increase linearly in accordance to length of the contact spot (see Figure 1.61). The influence of the flag is more evident under small speed. In

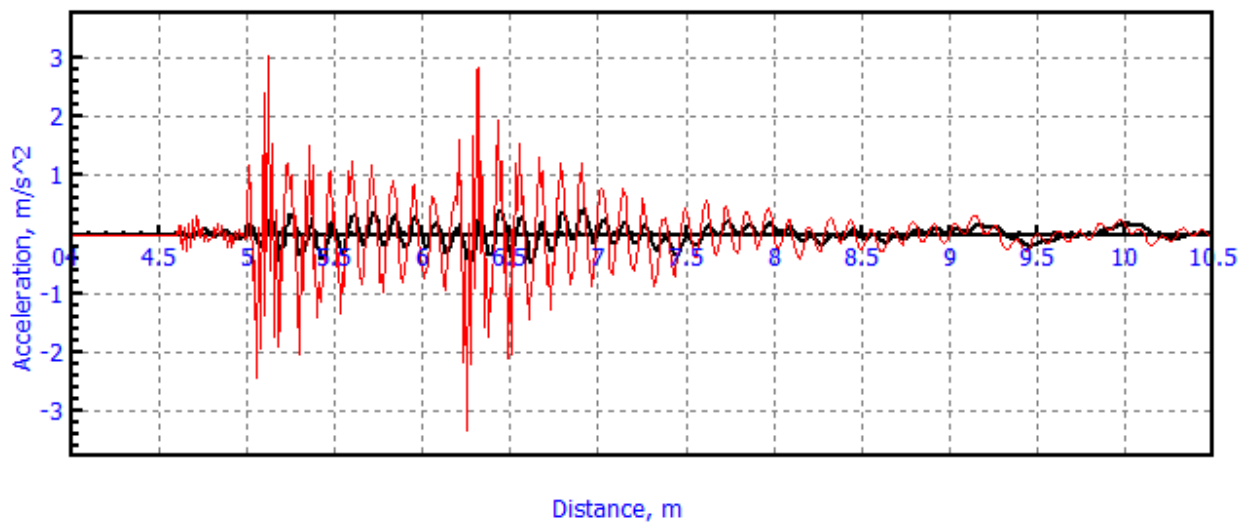

Figure 1.62, the diagram of acceleration in the center of track section 30 meters in length under entry of the vehicle on the edge is shown as example.

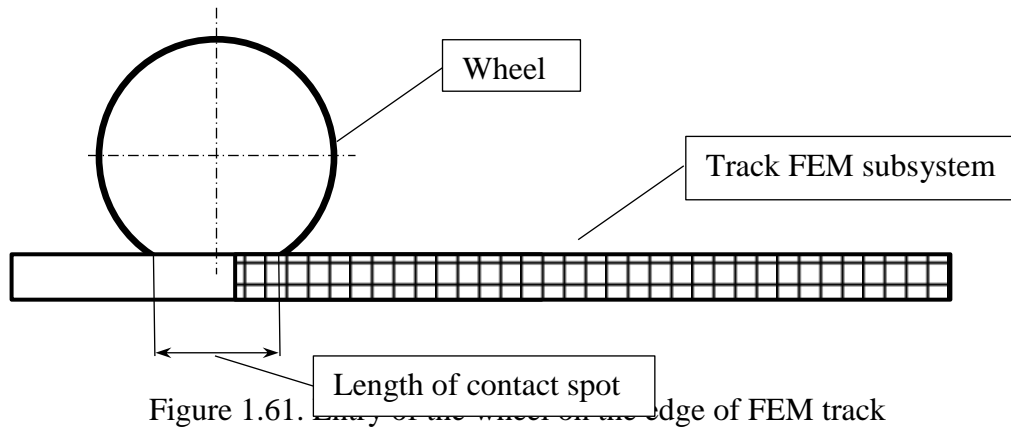

Figure 1.61. Entry of the wheel on the edge of FEM track

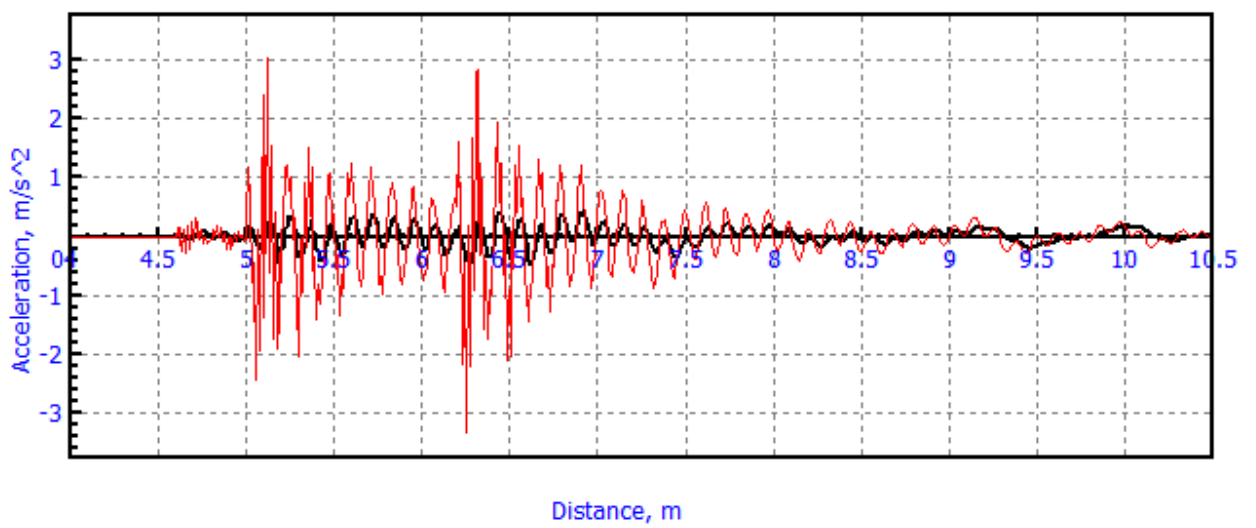

Figure 1.62. Acceleration in the center of track section 30 meters in length. Speed is 5 m/s. Black diagram is obtained with flag **Simulation of entry on edge**, red is calculated without one.

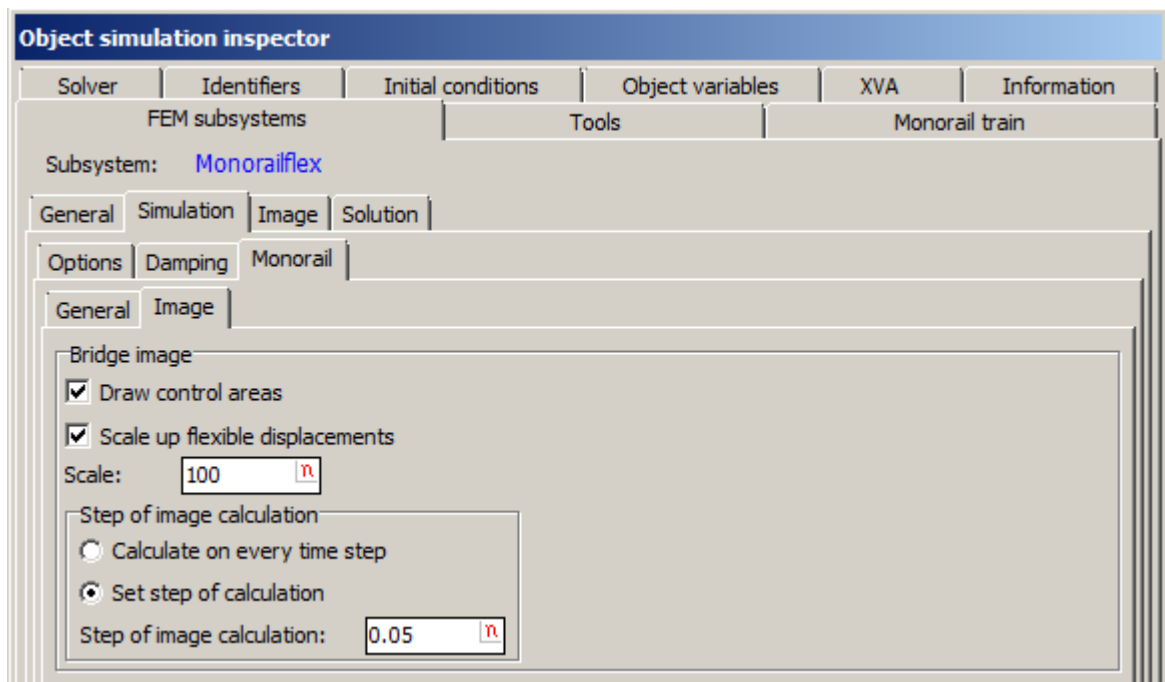

Figure 1.63. Tab **Image** of monorail **track**

On tab **Image** the following screen components are placed.

- **Draw control areas** flag shows control areas around the wheel interacting with the flexible track (Figure 1.64). A contact point is located into control polygon having red color. The yellow polygons are so called surrounding ones i.e. they are neighboring to the control polygon. This capacity allows detecting discrepancy in description of the macrogeometry and form of flexible subsystem simulating monorail track. If control area does not appear under the wheel placed on the subsystem surface, description of the model should be checked. In the current release, colors of the control area cannot be changed.
- **Scale up flexible displacement** flag allows displaying deflection with the scale specifying in the **Scale** field (Figure 1.65).
- Components in group box **Step of image calculation** allows to refresh the flexible track image with the step different from **Step size of animation data** inputted on the **Simulation process parameters** tab of **Object inspector**. If FE model of a monorail track consists of great number of finite elements, refresh of the image can take significant time. In this case, step of image calculation can be chosen greater than step size of animation and data storage. For example, if size of animation storage is 0.01 seconds and **Step of image calculation** is 0.05, the image of the FEM subsystem will be refreshed one time per 5 animation steps.

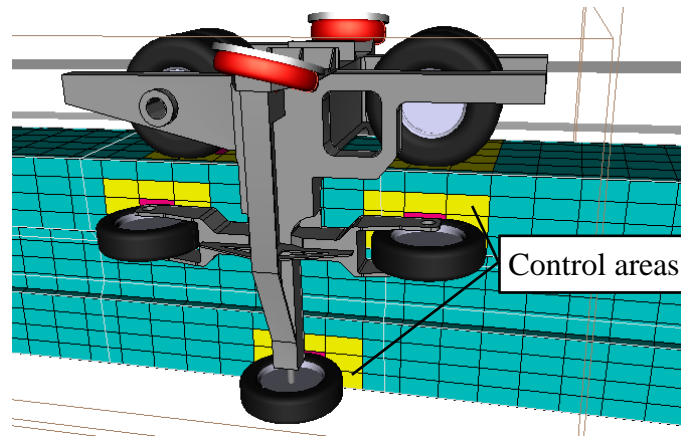

Figure 1.64. Control areas under wheels

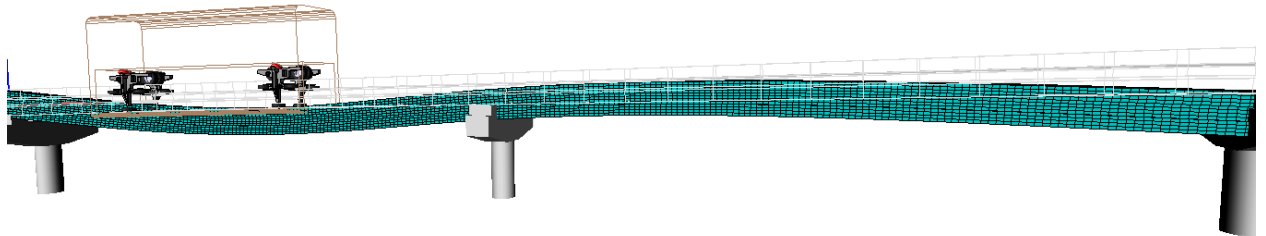

Figure 1.65. Flexible deflections of the monorail track are scaled in 200 times.

All analysis tools used for FEM subsystems and described in [Chapter 11](#) can be applied for study characteristics of the flexible monorail track section that it simulates. Besides, the special variables **dyBridge** and **dzBridge** created on tab **Monorail train** of the **Wizard of variables** are also supported.

### 1.8.3. Examples

Two examples of simulation of flexible track parts of monorail are available in site [www.universalmechanism.com](http://www.universalmechanism.com) by link [um\\_samples\\_fem\\_monorail.zip](#). They present supporting and suspended variants of monorail systems. Screen copies are shown in Figure 1.66 and Figure 1.67.

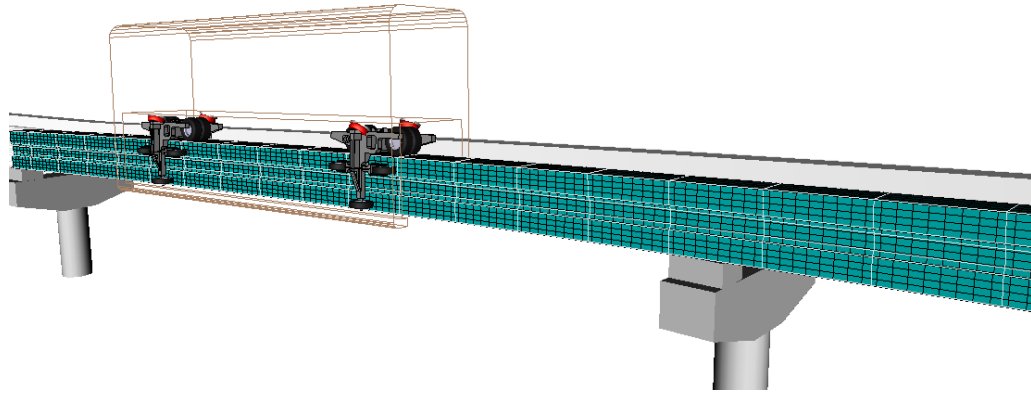

Figure 1.66. Model of supported monorail system from the set of UM samples

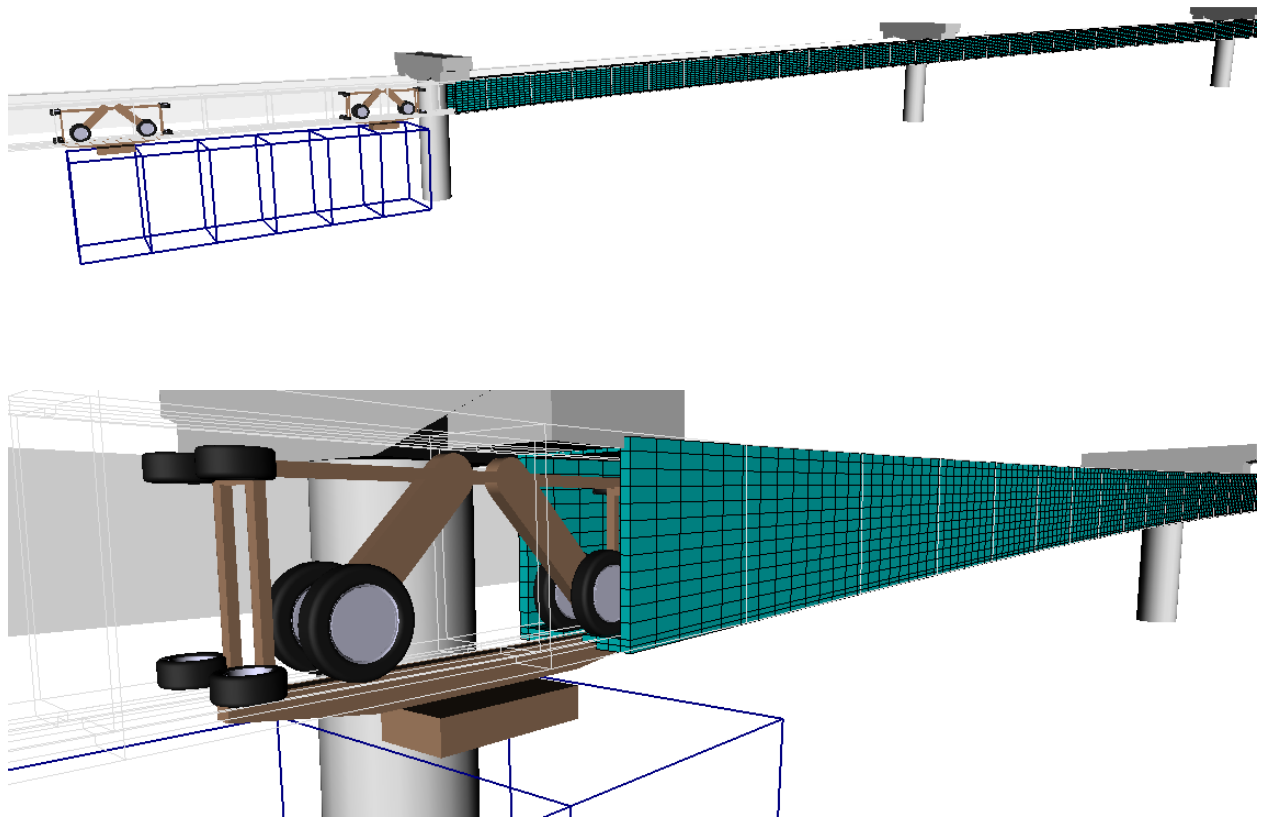

Figure 1.67. Model of suspended monorail system from the set of UM samples